



ROLLER/ ZEBRA™ SHADE COMPONENTS

All prices are subject to change without notice

FEB 16, 2024

Table Context

	Section
ADAPTORS (TUBE & CLUTCH ACCESSORIES)	1
BOTTOMRAILS / CAPS / RODS.....	2
BRACKETS (EZ, GL, FASCIA, BUTTED, DUOS, EZ-MATIC, MOTOR, ADJ ZEBRA)	3
CHAINS, CORDS & RELATED CHAIN PARTS.....	4
CLUTCHES.....	5
END PLUGS	6
EZ-MATIC (CORDLESS).....	7
MOTORIZATION	8
SCREWS	9
SHADE COVER, CLIPS, INSERTS (STANDARD & UN-FACE).....	10
PRIVACY SIDE CHANNEL	11
SPRING ASSIST LIFT	12
TAPES/INSERTS/SPLINES	13
TUBES	14
UNI PLATFORMS (UNI-Rails & UNI-Cassettes)	15
TOOLS & MACHINERY	16



ROLLER/ ZEBRA™ SHADE COMPONENTS

All prices are subject to change without notice

FEB 16, 2024

CLUTCH/TUBE ADAPTORS

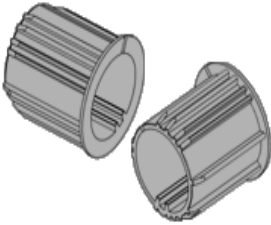
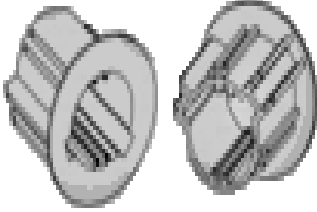
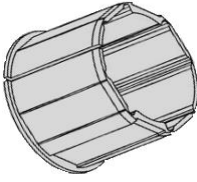
 <p>1</p>	<p>R-TA-U</p>	<p>UNIVERSAL TUBE ADAPTOR</p> <p>Adapts 32 ball clutch and end plug for both standard and Genesis 2" & 2-1/4" tube.</p> <p>For 2-1/4" tube, use screw R-SW-C-8SDS-Z to secure</p> <p>Available only in Light Gray</p>	<p>50 PCS / BAG</p> <p>500 PCS / BOX</p>
 <p>1</p>	<p>R-TA-U-2.5</p>	<p>UNIVERSAL 2.5" TUBE ADAPTOR</p> <p>Adapts 32 ball clutch and end plug for 2-1/2" tube</p> <p>Available only in Lt. Gray</p>	<p>50 PCS / BAG</p> <p>500 PCS / BOX</p>
 <p>1</p>	<p>GEN-1.625 ADAPTOR</p>	<p>ADAPTOR ONLY FOR GENESIS 1- 5/8" TUBE</p> <p>Adapts any 1.625" clutch spindles to the Genesis 1 5/8" Tube</p>	<p>100 / BAG</p> <p>2,000 / BOX</p>





ROLLER/ ZEBRA™ SHADE COMPONENTS

All prices are subject to change without notice

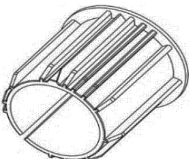
FEB 16, 2024

 <p style="text-align: right;">1</p>	<p>GEN-MOTOR35-SLEEVE2</p>	<p>GENESIS MOTOR35 ADPT SLEEVE2 (sleeve – fits over power wire end of motor for 2" Genesis tube - must be ordered with AC motor)</p>	<p>50 / BAG 1,000 / BOX</p>
--	-----------------------------------	---	---

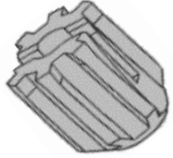
CLUTCH TORQUE SAFETY GUARDS

 <p>1</p>	<p>GEN-CL23-SGP-EZ-SW</p>	<p>EZ ROLL 23 BALL SAFEGUARD PLUG (prevents excessive torque twisting in 23 ball EZ Roll clutch heavy blinds)</p> <p><u>Available Colors:</u> Snow White ONLY</p>	<p>50 / BAG 5,000 / BOX</p>
 <p>1</p>	<p>R-CL32-SGP-EZ</p>	<p>SPRING ASSIST CLUTCH SAFETY GUARD PLUG (prevents excessive torque twisting in 32 ball EZ Roll clutch heavy blinds)</p> <p>Top Half of R-CL32-SGP-GL-X (Guide Line Safety Guard Plug)</p>	<p>50 PCS / BAG</p>



ROLLER/ ZEBRA™ SHADE COMPONENTS

All prices are subject to change without notice

FEB 16, 2024

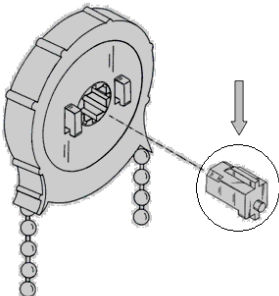
 <p>1</p>	<p>R-CL32-SGP-GL-X</p>	<p>GUIDELINE SAFETY GUARD INSERT PLUG FOR 32 BALL CLUTCHES</p> <p>Backup safety support for weight</p> <p><u>Available Colors:</u> (B) Black, (W) Snow White</p> <p>US Patent Pending Taiwan Patent # M459810</p>	<p>50 PCS / BAG</p>
---	-------------------------------	--	----------------------------

CLUTCH FABRIC SHIELD GUARDS



<p>**NEW 2018 **</p>  <p>1</p>	<p>R-FG1.8-U-0.75</p>	<p>UNIVERSAL FABRIC SHIELD, PLASTIC CLEAR, for 13 Ball Mini Clutch, 3/4" Tube</p> <ul style="list-style-type: none"> • Outside Diameter 1 3/4" <p>Used with Mini 3 & 5 lb clutch for smaller shades. Prevents fabric riding over clutch</p> <p>US Patent #D690,961S</p>	<p>50 PCS / BAG</p>
---	------------------------------	--	----------------------------



ROLLER/ ZEBRA™ SHADE COMPONENTS

All prices are subject to change without notice

FEB 16, 2024

 <p>1</p>	<p>DISCONTINUED</p> <p>R-FG2.5-U</p>	<p>UNIVERSAL FABRIC SHIELD, PLASTIC CLEAR, for 23 Ball Clutch, 1-1/8" & 1 1/4" Tube</p> <p>Prevents fabric riding over clutch</p> <ul style="list-style-type: none"> • Outside Diameter 2 1/2" <p>Used with 5 lb. & 8 lb. clutch for longer length shades. Prevents fabric riding over clutch</p> <p>US Patent #D690,961S</p>	<p>50 PCS / BAG</p>
 <p>1</p>	<p>R-FG2.5-U-1.5</p>	<p>UNIVERSAL FABRIC SHIELD, PLASTIC CLEAR, for 23 Ball, 1 1/2" & 1 5/8" Tube</p> <ul style="list-style-type: none"> • Outside Diameter 2 1/2" <p>Used with 8 & 10 lb. clutch of longer length shades. Prevents fabric riding over clutch</p> <p>US Patent #D690,961S</p>	<p>50 PCS / BAG</p>
 <p>1</p>	<p>R-FG3-U</p>	<p>UNIVERSAL FABRIC SHIELD, PLASTIC CLEAR for 23 Ball, 1-1/2" & 1-5/8" Tube</p> <ul style="list-style-type: none"> • Outside Diameter 2 7/8" <p>Used with 8 & 10 lb. clutch of longer length shades. Prevents fabric riding over clutch</p> <p>US Patent #D690,961S</p>	<p>50 PCS / BAG</p>



ROLLER/ ZEBRA™ SHADE COMPONENTS

All prices are subject to change without notice

FEB 16, 2024

 <p>1</p>	<p>R-FG3.75-U</p>	<p>UNIVERSAL FABRIC SHIELD, PLASTIC CLEAR for 32 Ball, 1-½" & 1-5/8" Tube</p> <ul style="list-style-type: none"> • Outside Diameter 3 3/4" <p>Used with 8 & 10 lb. clutch of longer length shades. Prevents fabric riding over clutch</p> <p>US Patent #D690,961S</p>	<p>50 PCS / BAG</p>
---	--------------------------	--	----------------------------

BOTTOMRAILS & CAPS 2

STANDARD BOTTOMRAIL, CAPS & RODS

 <p>2</p>	<p>R-MBRE-U-XX</p>	<p>MINI ELLIPTICAL BOTTOMRAIL (16 FT) ALUMINUM</p> <ul style="list-style-type: none"> - Use End Cap R-EC-MBRE-XX - Use Plastic Insert R-M-T-PI-6T or 7T To Wrap Fabric - Use R-RF-BRR-12 Fiberglass Rod <p><u>Available Colors:</u> (BK) Black, (SW) Snow White, (IV) Ivory, (SI) Silver</p> <p><u>Available Discontinued Colors:</u> (BN) Bronze</p>	<p>10PCS/BUNDLE (160 FT)</p>
---	---------------------------	---	---



ROLLER/ ZEBRA™ SHADE COMPONENTS

All prices are subject to change without notice

FEB 16, 2024

 <p>2</p>	<p>R-EC-MBRE-U-XX</p>	<p>MINI END CAP FOR MINI ELIPTICAL BR Use screw R-SW-BR-S12A</p> <p>Hold down hole</p> <p><u>Available Colors:</u> (BK) Black, (SW) Snow White, (IV) Ivory, (SI) Silver</p> <p><u>Available Discontinued Colors:</u> (BN) Bronze</p>	<p>100 PCS / BAG</p> <p>5,000 / BOX</p>
 <p>2</p>	<p>1.5"-HDB</p>	<p>UNIVERSAL HOLD DOWN BRACKETS WITH PIN, STAINLESS STEEL</p>	<p>500 PCS / BAG</p>
 <p>2</p>	<p>Discontinued R-BRR-U-XX</p>	<p>UNIVERSAL ANODIZED ALUMINUM ROUND BOTTOMRAIL (16 FT)</p> <ul style="list-style-type: none"> Diameter 7/8" <p>End Cap R-EC-BRR-XX</p> <p><u>Available Colors: (XX)</u> (BK) Black, (BN) Bronze, (SI) Silver</p>	<p>10 PCS/BUNDLE (160 FT)</p>
 <p>2</p>	<p>Discontinued R-EC-BRR-XX</p>	<p>END CAP FOR ROUND BOTTOMRAIL,</p> <p>Use Screw R-SW-BR-S12A (Not Included)</p> <p><u>Available Color (XX):</u> (BK) Black, (BN) Bronze, (SI) Silver (SW) Snow White</p>	<p>500 PCS/BAG</p> <p>5,000 / BOX</p>



ROLLER/ ZEBRA™ SHADE COMPONENTS

All prices are subject to change without notice

FEB 16, 2024

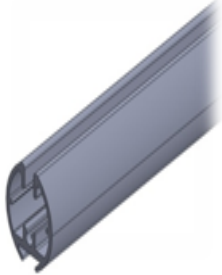
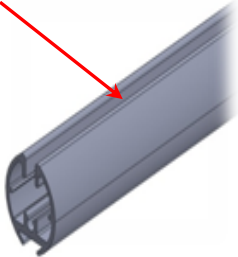
 <p>2</p>	<p>Discontinued R-BRE-U-XX</p>	<p>UNIVERSAL ANODIZED ALUMINUM ELLIPTICAL BOTTOMRAIL (16 FT)</p> <ul style="list-style-type: none"> • Diameter: 3/4" X 3/4" • 3.5mm opening <p>End Cap R-EC-BRE-XX</p> <p>Available Colors: (XX) (BK) Black, (BN) Bronze, (IV) Ivory</p> <p>US Patent#D692,6855</p>	<p>10 PCS/BUNDLE (160 FT)</p>
<p>*NEW 2019 Larger opening</p>  <p>2</p>	<p>R-BRE2-U-XX</p>	<p>UNIVERSAL ANODIZED ALUMINUM ELLIPTICAL BOTTOMRAIL (16 FT)</p> <ul style="list-style-type: none"> • Diameter: 3/4" X 3/4", • 4.5mm opening-For thicker fabrics <p>End Cap R-EC-BRE-XX</p> <p>Available Colors:(XX) (BK) Black, (SI) Silver, (SW) Snow White</p> <p>Available Discontinued Colors:(XX) (BN) Bronze, (IV) Ivory</p> <p>US Patent#D692,6855</p>	<p>10 PCS/BUNDLE (160 FT)</p>



ROLLER/ ZEBRA™ SHADE COMPONENTS

All prices are subject to change without notice

FEB 16, 2024

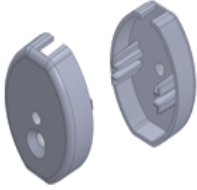
 2	R-EC-BRE-XX	END CAP FOR ELLIPTICAL BOTTOM RAIL R-BRE-U-XX & R-BRE2-U-XX Use Screw R-SW-BR-S12A(Not Included) <u>Available Color (XX):</u> (BN) Bronze, (C) Clear, (SI) Silver (SW) Snow White <u>Available Discontinued Color (XX):</u> (BN) Bronze, (IV) Ivory	500 PCS/BAG 5,000/BOX
--	--------------------	--	--



ROLLER/ ZEBRA™ SHADE COMPONENTS

All prices are subject to change without notice

FEB 16, 2024

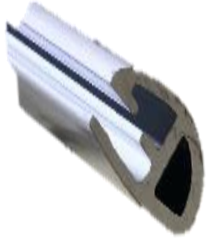

<p>**NEW 2019</p>  <p>2</p> <p>2</p>	<p>R-BRSL-XX</p>	<p>SLENDER BOTTOMRAIL (16 FT) (cannot be wrapped)</p> <p>Height: 15mm Thickness: 9mm Opening: 2mm</p> <p>Use Plastic Insert: R-M-T-PI-8T End Cap R-EC-BRSL-XX</p> <p>Use when you want to minimize the bottom rail's appearance. Made for Inspiration but may be used on all shades.</p> <p><u>Available Colors: (XX)</u> (SI) Silver Grey, (SW) Snow White (BK) Black</p>	<p>20 PCS/BUNDLE</p>
--	-------------------------	--	-----------------------------



ROLLER/ ZEBRA™ SHADE COMPONENTS

All prices are subject to change without notice

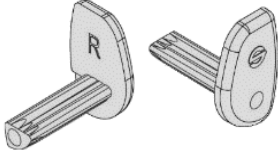
FEB 16, 2024

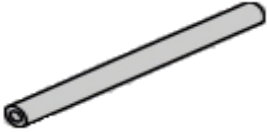

<p>**NEW 2019</p>  <p>2</p>	<p>R-EC-BRSL-XX</p>	<p>END CAP FOR SLENDER BOTTOMRAIL</p> <p>Has a left & right (Set)</p> <p><u>Available Colors: (XX)</u> (SI) Silver Grey, (SW) Snow White</p>	<p>500 SETS/BAG 5000 SETS/BOX</p>
 <p>2</p>	<p>R-BRP-U-SI</p>	<p>ELLIPSE HEM POCKET ANODIZED ALUMINUM BOTTOMRAIL BAR (16 FT) 1 ½" L x 0.25" W</p> <p>For welded pockets</p> <p><u>Available Colors: (XX)</u> Silver Only</p> <p>US Patent No. D691,398S Taiwan Patent No. M450613</p>	<p>10 PCS/BUNDLE (160 FT)</p>
 <p>2</p>	<p>R-RF-BRR-12</p>	<p>3.5mm <u>SOLID</u> FIBERGLASS ROD - 12 FT</p> <p>Use on Round Bottom Rail (R-BRR-U-XX) or Elliptical Bottom Rail (R-BRE-U-XX)</p> <p>Diameter 3.5mm (0.1378")</p>	<p>30 PCS/BAG 300 PCS/BUNDLE</p>



ROLLER/ ZEBRA™ SHADE COMPONENTS

All prices are subject to change without notice

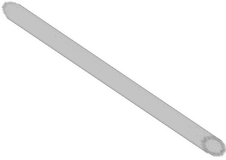
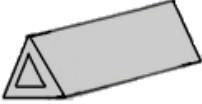
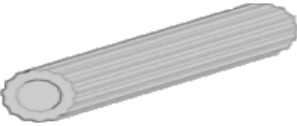
FEB 16, 2024

<p>** NEW 2019 **</p>  <p>2</p>	<p>R-RF-BRE2-5mm</p>	<p>5.0mm <u>SOLID</u> FIBERGLASS ROD- 12FT</p> <p>Use on NEW Elliptical Bottom Rail, R-BRE2-U-XX for Thick Fabric.</p> <p>5mm (0.2")</p>	<p>10 PCS/BAG</p> <p>200 PCS/BUNDLE</p>
 <p>2</p>	<p>R-RT-BRR-12</p>	<p>CLEAR PLASTIC TRIANGLE TUBE, 12 FT</p> <p>7.5x6.5x6.5mm (0.2953"x0.2559"x0.2559")</p> <p>Insert to ROUND BOTTOM RAIL, R-BRR-U-XX</p>	<p>100 PCS/ BUNDLE</p>
 <p>2</p>	<p>R-RA-BRR-16</p>	<p>4.4mm <u>HOLLOW</u> RIPPLED ALUMINUM ROD, 16 FT</p> <p>Use on Round Bottom Rail (R-BRR-U-XX) or Elliptical Bottom Rail (R-BRE-U-XX)</p> <p>Outside diameter 4.4mm (0.1732")</p>	<p>100 PCS/ BUNDLE</p>
 <p>2</p>	<p>TR-H</p>	<p>5.6MM <u>SOLID</u> HEX STEEL(Galvanized) ROD, 16 FT</p> <p>Use to add extra weight to bottom rail if needed</p>	<p>24 PCS / BUNDLE (384 FT)</p>



ROLLER/ ZEBRA™ SHADE COMPONENTS

All prices are subject to change without notice

FEB 16, 2024

ZEBRA SHADE™ BOTTOMRAILS, CAPS & RODS

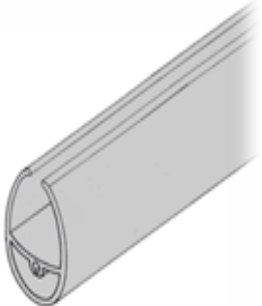
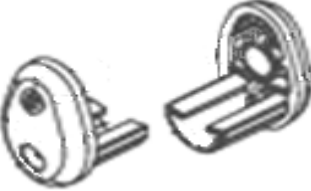
 <p>2</p>	<p>R-BR-ZBP2-XX</p>	<p>ZEBRA PRO#2, 8mm Opening BOTTOMRAIL- 16FT Use End Caps R-EC-ZBP-XX Not Suitable For Pleated Fabrics</p> <p>Weight: 0.18 LB per FT</p> <p><u>Available Colors:</u> (XX):(SW) Snow White <u>Available Discontinued Colors:</u> (XX) (BK) Black, (BN) Bronze, (IV) Ivory, (SI) Silver,</p> <p>Chinese Patent CN204060463-U</p>	<p>10PCS/ BUNDLE (160 FT)</p>
 <p>Use Screw R-SW-BR-S12A (Not included)</p> <p>2</p>	<p>R-EC-ZBP-XX</p>	<p>ZEBRA PRO BOTTOMRAIL ENDCAP</p> <p>For both R-BR-ZBP & P2-XX</p> <p><u>Available Colors:</u> (XX):(SW) Snow White</p> <p><u>Available Discontinued Colors:</u> (XX) (BK) Black, (BN) Bronze, (IV) Ivory, (SI) Silver</p> <p>Chinese Patent CN204060463-U Taiwan Patent M495420</p>	<p>100 / BAG 5,000 / BOX</p>



ROLLER/ ZEBRA™ SHADE COMPONENTS

All prices are subject to change without notice

FEB 16, 2024

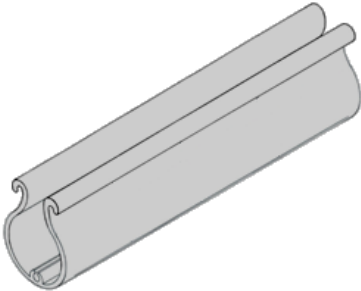
 <p>2</p>	<p>R-BR-ZBP5-XX</p>	<p>ZEBRA PRO5, 8.25mm Opening BOTTOMRAIL - 16FT</p> <p>Uses End Caps R-EC-BRP5-NS-XX OR R-EC-BRP5-NEW-XX</p> <p>Suitable For Pleated Fabrics <u>Available Colors: (XX)</u> (SI) Silver, (SW) Snow White</p> <p><u>Available Discontinued Colors: (XX)</u> (BK) Black, (BN) Bronze, (IV) Ivory,</p> <p>U.S. Patent D793,765 S Chinese Patent CN204060463-U</p>	<p>10 PCS/ BUNDLE (160 FT)</p>
 <p>(Screws included)</p> <p>2</p>	<p>Discontinued R-EC-BRP5-NS-XX</p>	<p>ZEBRA PRO 5 BOTTOMRAIL ENDCAP</p> <p><u>Available Colors: (XX)</u> (BK) Black, (BN) Bronze, (IV) Ivory, (SI) Silver, (SW) Snow White</p> <p>U.S. Patent Pending Chinese Patent CN204060463-U Taiwan Patent M495420</p>	<p>100 / BAG 2000 / BOX</p>



ROLLER/ ZEBRA™ SHADE COMPONENTS

All prices are subject to change without notice

FEB 16, 2024

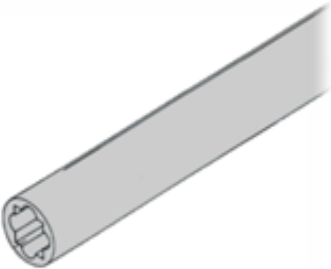
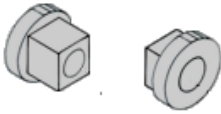

<p>**NEW 2020 **</p>  <p>(Screws included)</p> <p>2</p>	<p>R-EC-BRP5-NEW-XX</p>	<p>ZEBRA PRO 5 BOTTOMRAIL ENDCAP</p> <p><u>Available Colors: (XX)</u> (SW) Snow White, (SI) Silver, (Bk) Black, (BN) Brown (IV) Ivory,</p> <p>U.S. Patent Pending Chinese Patent CN204060463-U Taiwan Patent M495420</p>	<p>100 / BAG</p> <p>3000 / BOX</p>
 <p>2</p>	<p>R-BRR-ZB.5-XX</p>	<p>ZEBRA BOTTOM RAIL SMOOTH ROUND ROD, 1/2" Diameter - 16FT</p> <p>Use inside Zebra bottom rails: R-BR-ZBP2-XX & R-BR-ZBP5-XX</p> <p>End Cap: R-EC-BRR-ZB</p> <p>Weight: 0.133 LB per FT</p> <p><u>Available Colors:</u> (SW) Snow White,</p>	<p>10 PCS/ BUNDLE</p> <p>(160 FT)</p>
 <p>2</p>	<p>Discontinued Replaced by R-EC-BRR-ZB2 R-EC-BRR-ZB</p>	<p>END CAP ADAPTOR, Plastic white For ZEBRA BOTTOM RAIL SMOOTH ROUND ROD</p> <p>Chinese Patent CN204060463-U Taiwan Patent M495420</p>	<p>200 PCS / BAG</p>



ROLLER/ ZEBRA™ SHADE COMPONENTS

All prices are subject to change without notice

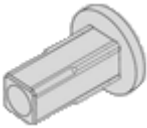
FEB 16, 2024

 <p>2</p>	<p>R-EC-BRR-ZB2</p>	<p>PLASTIC END CAP ADAPTOR For ZEBRA BOTTOM RAIL (R-BR-ZBPS-XX) SMOOTH ROUND Rod (R-BRR-ZB.5-XX)</p> <p>Chinese Patent CN204060463-U Taiwan Patent M495420</p>	<p>200 PCS / BAG</p>
<p>** NEW 2020 **</p>  <p>2</p>	<p>R-BRR-ZB-SW</p>	<p>3/8" SMOOTH ROUND ROD FOR ZEBRA BOTTOM RAIL Diameter - 16FT ID: 4.7mm, OD: 10mm</p> <p>Use inside Zebra #5 bottom rails, item# R-BR-ZBP5-XX</p> <p>* Made special for pleated and thicker fabric shades</p> <p><u>Available Color:</u> (SW) Snow White ONLY</p>	<p>10 PCS/ BUNDLE (160 FT)</p>





ROLLER/ ZEBRA™ SHADE COMPONENTS

All prices are subject to change without notice

FEB 16, 2024

BRACKETS 3

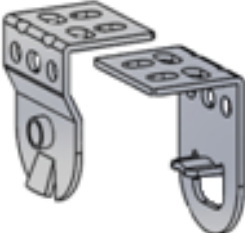
MINI BRACKETS

 <p>3</p>	<p>Discontinued R-IB23-MEZ-CL/EP-XX</p>	<p>MINI EZ CLUTCH/END PLUG BRACKETS</p> <p>23mm to center hole</p> <p>Used on adjustable UNI-Rail-Zebra shade</p> <p>Holds 3 LBS maximum weight</p> <p><u>Available Colors: (XX)</u> (BK) Black, (SW) Snow White</p>	<p>25 SET/BAG</p>
 <p>3</p>	<p>Discontinued R-IB35-MEZ-CL/EP-XX</p>	<p>MINI EZ-CLUTCH/END PLUG BRACKETS</p> <p>35mm to center hole</p> <p>Holds 4 LBS maximum weight</p> <p><u>Available Colors: (XX)</u> (BK) Black, (SW) Snow White</p>	<p>25 SET/BAG</p>

EZ ROLL & GUIDELINE STANDARD BRACKETS (FOR REGULAR ROLLER & ZEBRA)



ROLLER/ ZEBRA™ SHADE COMPONENTS

All prices are subject to change without notice

FEB 16, 2024

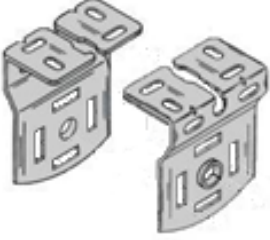
 <p>3</p>	<p>Discontinued</p> <p>R-IB35-EZ23-BK</p> <p>BLACK</p>	<p>EZ ROLL INSTALLATION BRACKET 35mm from top to center of hole For 23 Ball Clutches Clutch Prong is 12.5mm</p> <p><u>Available Colors: (XX)</u> (BK) Black</p> <p>US Patent No D683,565S Taiwan Patent No M459810</p>	<p>50 SETS / BAG</p> <p>200 SETS/ BOX</p>
 <p>3</p> <p>3</p>	<p>Replaced by R-IB35UC-GL-XX</p> <p>R-IB35-GL-XX</p> <p>ZINC</p> <p>BLACK(discontinued color) & WHITE</p>	<p>GL INSTALLATION BRACKET 35mm Height (1 3/8") - From top to center of hole For 23 Ball Clutches & no Positioneer EZ Matics</p> <p><u>Available Colors: (XX)</u> (BK) Black, (Z) Zinc, (SW) Snow White</p> <p>US Patent # D683565S TW Patent# M467417 & M459810</p>	<p>10 SETS / BAG</p> <p>100 SETS/ BOX</p>



ROLLER/ ZEBRA™ SHADE COMPONENTS

All prices are subject to change without notice

FEB 16, 2024



 <p>3</p>	<p>** Discontinued ** (NOV / 2019) REPLACED BY: R-IB45UC-EZ23-XX</p> <p>Remaining Stock R-IB45-EZ23-XX</p> <p>ZINC</p> <p>BLACK</p>	<p>EZ ROLL INSTALLATION BRACKET 45mm from top to center of hole</p> <p>For 23 Ball Clutches Clutch Prong is 12.5mm</p> <p><u>Available Colors: (XX)</u> (BK) Black, (Z) Zinc</p> <p>US Patent No D683,565S Taiwan Patent No M459810</p>	<p>50 SETS / BAG</p> <p>200 SETS/ BOX</p>
 <p>3</p>	<p>Discontinued</p> <p>R-IB45-EZ32-XX</p> <p>BLACK & WHITE</p>	<p>EZ ROLL INSTALLATION BRACKET 45mm from top to center of hole</p> <p>For 32 Ball Clutches Clutch Prong is 13.5mm</p> <p><u>Available Colors: (XX)</u> (BK) Black, (SW) Snow White, (Z) Zinc</p> <p>US Patent No D683,565S Taiwan Patent No M459810</p>	<p>50 SETS/ BAG</p> <p>200 SETS/ BOX</p>



ROLLER/ ZEBRA™ SHADE COMPONENTS

All prices are subject to change without notice

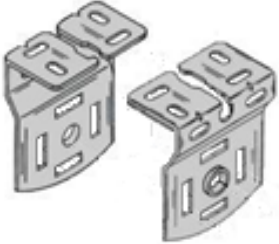
FEB 16, 2024

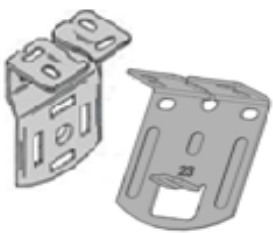

 <p>3</p>	<p>Discontinued</p> <p>Replaced by R-IB45UC-GL-XX</p> <p>R-IB45-GL-XX</p> <p>BLACK</p>	<p>GL INSTALLATION BRACKET 45mm Height (1 3/4") - From top to center of hole For 23 Ball & 32 Ball Clutches Also used in EZ-Matic with no Positioneer</p> <p><u>Available Colors:</u> (XX) (BK) Black</p> <p>US Patent # D683565S TW Patent# M467417 & M459810</p>	<p>10 SETS / BAG</p> <p>100 SETS/ BOX</p>
<p>** NEW 2020**</p>  <p>3</p>	<p>Discontinued</p> <p>R-IB35UC-GL-(X)</p> <p>WHITE</p>	<p>GL INSTALLATION BRACKET 40mm top width, 35mm Height (1 3/8") - From top to center of hole For 23 Ball Clutches</p> <p><u>Available Colors:</u> (X) (W) White</p> <p>US Patent # D683565S TW Patent# M467417 & M459810</p>	<p>50 SETS / BAG</p> <p>100 SETS/ BOX</p>
<p>** NEW 2020**</p>  <p>3</p>	<p>R-IB35UC-EZ23-(X)</p> <p>ZINC:</p> <p>WHITE:</p>	<p>EZ ROLL INSTALLATION BRACKET 40mm top width, 35mm from top to center of hole</p> <p>23 Ball Clutch Clutch Prong is 12.5mm</p> <p><u>Available Colors:</u> (X) (Z) Zinc, (W) White</p>	<p>50 SETS / BAG</p> <p>250 SETS/ BOX</p>



ROLLER/ ZEBRA™ SHADE COMPONENTS

All prices are subject to change without notice

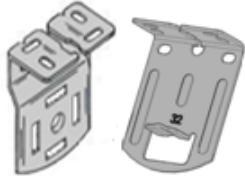
FEB 16, 2024

<p>** NEW 2019**</p>  <p>3</p>	<p>R-IB45UC-EZ23-(X)</p> <p>ZINC:</p> <p>WHITE:</p>	<p>EZ ROLL INSTALLATION BRACKET 40mm top width, 45mm from top to center of hole</p> <p>23 Ball Clutch Clutch Prong is 12.5mm</p> <p><u>Available Colors:</u> (X) (Z) Zinc, (W) White</p>	<p>50 SETS / BAG</p> <p>250 SETS/ BOX</p>
<p>** NEW 2019**</p>  <p>3</p>	<p>R-IB45UC-EZ32-(X)</p> <p>ZINC:</p> <p>WHITE:</p>	<p>EZ ROLL INSTALLATION BRACKET 40mm top width, 45mm from top to center of hole</p> <p>32 Ball Clutch Clutch Prong is 13.5mm</p> <p><u>Available Colors:</u> (X) (Z) Zinc, (W) White</p>	<p>50 SETS / BAG</p> <p>250 SETS/ BOX</p>
<p>** NEW 2020**</p>  <p>3</p>	<p>R-IB45UC-GL-XX</p> <p>WHITE</p>	<p>GL INSTALLATION BRACKET 40mm top width, 45mm from top to center of hole</p> <p>For 23 Ball & 32 Ball Clutches</p> <p><u>Available Colors:</u> (XX) (SW) Snow White</p> <p>US Patent # D683565S TW Patent# M467417 & M459810</p>	<p>50 SETS / BAG</p> <p>100 SETS / BOX</p>



ROLLER/ ZEBRA™ SHADE COMPONENTS

All prices are subject to change without notice

FEB 16, 2024

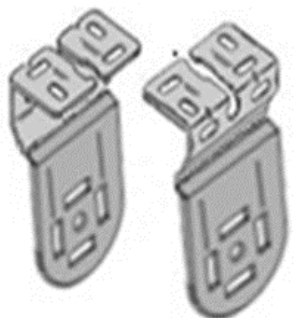
 <p>3</p>	<p>Discontinued</p> <p>R-IB55-EZ32-XX</p>	<p>EZ ROLL INSTALLATION BRACKET</p> <p>55mm (2-5/32") from top to center of hole For 32 Ball, 24 LB Clutches, 2.5" Tube Clutch Prong is 13.5mm</p> <p><u>Available Colors:</u> (Z) Zinc only</p> <p>US Patent No D683,565S Taiwan Patent No M459810</p>	<p>50 SETS/ BAG</p> <p>100 SETS / BOX</p>
 <p>3</p>	<p>Discontinued</p> <p>R-IB55-GL-XX</p> <p>ZINC</p> <p>BLACK & WHITE</p>	<p>GL INSTALLATION BRACKET</p> <p>55mm Height (2 5/32") – From top to center of hole For 32 Ball Clutches</p> <p><u>Available Colors: (XX)</u> (Z) Zinc (BK) Black, (SW) Snow White,</p> <p>US Patent # D683565S TW Patent# M467417 & M459810</p>	<p>25 SETS / BAG</p> <p>100 SETS / BOX</p>



ROLLER/ ZEBRA™ SHADE COMPONENTS

All prices are subject to change without notice

FEB 16, 2024

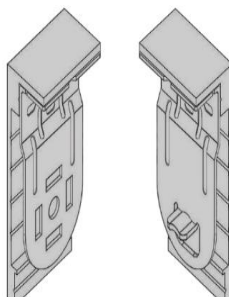
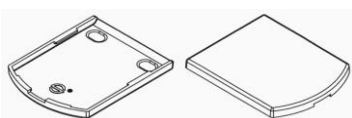
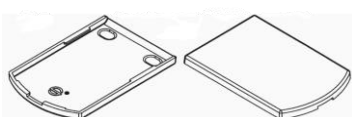
<p>** NEW 2019**</p>  <p>3</p>	<p>R-IB59HD-EZ</p>	<p>EZ ROLL HEAVY DUTY BRACKET 55mm (2-5/32") from top to center of hole</p> <p>For 32 Ball Clutch Pull using Genesis 2" TUBE Clutch Prong is 13.5mm</p> <p>Max shade 9'X13' Max weight 10 lbs.</p> <p>Spring Assist Max weight 16 lbs.</p>	<p>1 SET/ BAG</p>
 <p>3</p>	<p>R-IB35UC-EZ23Cover-xx</p>	<p>Bracket cover for R-IB35UC-EZ23-(X)</p> <p>NEW COVER 40mm(W), 35mm DROP, EZ-ROLL, 23-BALL, WHITE</p> <p>Available Colors: (XX) (SW) Snow White (B) Black</p>	<p>50 SETS / BAG</p>
 <p>3</p>	<p>R-IB45UC-EZ23Cover-xx</p>	<p>Bracket cover for R-IB45UC-EZ23-(X)</p> <p>NEW COVER 40mm(W), 45mm DROP, EZ-ROLL, 23-BALL, WHITE</p> <p>Available Colors: (XX) (SW) Snow White (B) Black</p>	<p>50 SETS / BAG</p>



ROLLER/ ZEBRA™ SHADE COMPONENTS

All prices are subject to change without notice

FEB 16, 2024

 <p>3</p>	<p>R-IB35UC-GL-Cover-xx</p>	<p>Bracket cover for R-IB35UC-GL-(X)</p> <p>NEW COVER 40mm(W), 35mm DROP, GUIDELINE, 23-BALL, WHITE</p> <p><u>Available Colors:</u> (XX) (SW) Snow White</p>	<p>50 SETS / BAG</p>
 <p>3</p>	<p>R-IB45UC-GL-Cover-xx</p>	<p>Bracket cover for R-IB45UC-GL-(X)</p> <p>NEW COVER 40mm(W), 45mm DROP, GUIDELINE, 23-BALL, WHITE</p> <p><u>Available Colors:</u> (XX) (SW) Snow White</p>	<p>50 SETS / BAG</p>

FASCIA STANDARD BRACKETS

 <p>3</p>	<p>Discontinued</p> <p>R-IB-F423-EZ-XX</p>	<p>EZ INSTALLATION BRACKET with SAFETY CLIP FOR 3" FLAT FASCIA</p> <p>35mm (1.365") from top to center of hole</p> <ul style="list-style-type: none"> • Width: 2 3/4" • Height: 2 3/4" <p>Only For 23 Ball Clutch Clutch Prong is 12.5mm</p> <p><u>Available Colors:</u> (BK) Black, (BN) Bronze</p> <p>US Patent No 8,967,227B2 Taiwan Patent No M463096 China Patent No CN 203230329U</p>	<p>1 SET / BAG 50 SETS / BOX</p>
--	---	--	--------------------------------------

Main Office: 620 S. Jefferson St. Unit A, Placentia, CA 92870 Tel (800) 441-2024 Fax (800) 787-5369
4570 Shelby Air Dr. Suite 6, Memphis, TN 38118 Tel (901) 360-0058 Fax (901) 365-3007



ROLLER/ ZEBRA™ SHADE COMPONENTS

All prices are subject to change without notice

FEB 16, 2024

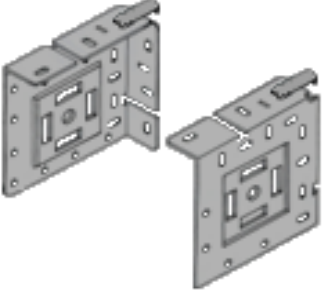
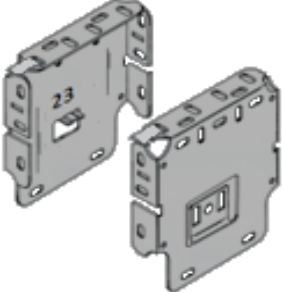
 <p>3</p>	<p>Discontinued R-IB-F423-GL-XX</p>	<p>GL INSTALLATION BRACKET with SAFETY CLIP FOR 3" FLAT FASCIA</p> <p>35mm (1.365") from top to center of hole</p> <ul style="list-style-type: none"> • Width: 2 3/4" • Height: 2 3/4" <p>Only For 23 Ball Clutch</p> <p><u>Available Colors:</u> (BK) Black, (BN) Bronze, (SW) Snow White</p> <p>US Patent No 8,967,227B2 Taiwan Patent No M463096 China Patent No CN 203230329U</p>	<p>1 SET / BAG 50 SETS / BOX</p>
 <p>3</p>	<p>R-IB-F4-EZ23-XX</p>	<p>EZ ROLL INSTALLATION BRACKET WITH SAFETY CLIP FOR 3" & 4" FLAT FASCIA</p> <p>45mm (1.772") from top to center of hole</p> <ul style="list-style-type: none"> • Width: 3.25" • Height: 3" <p>For 23 Ball Clutches Clutch Prong is 12.5mm</p> <p><u>Available Colors:</u> (BK) Black, (BN) Bronze, (SW) Snow White</p> <p>US Patent No 8,967,227B2 Taiwan Patent No M463096 China Patent No CN 203230329U</p>	<p>10 SET / BAG 50 SETS / BOX</p>



ROLLER/ ZEBRA™ SHADE COMPONENTS

All prices are subject to change without notice

FEB 16, 2024

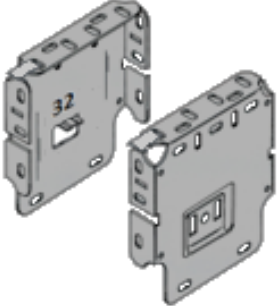
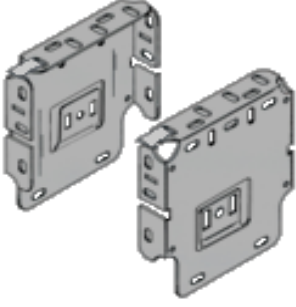
 <p>3</p>	<p>R-IB-F4-EZ32-XX</p>	<p>EZ ROLL INSTALLATION BRACKET WITH SAFETY CLIP FOR 3" & 4" FLAT FASCIA</p> <p>45mm (1.772") from top to center of hole</p> <ul style="list-style-type: none"> • Width: 3.25" • Height: 3" <p>For 32 Ball Clutches Clutch Prong is 13.5mm</p> <p><u>Available Colors:</u> (BK) Black, (BN) Bronze, (SW) Snow White</p> <p>US Patent No 8,967,227B2 Taiwan Patent No M463096 China Patent No CN 203230329U</p>	<p>10 SET / BAG 50 SETS / BOX</p>
 <p>3</p>	<p>R-IB-F4-GL-XX</p>	<p>GL INSTALLATION BRACKET WITH SAFETY CLIP FOR 3" & 4" FLAT FASCIA</p> <p>45mm (1.772") from top to center of hole</p> <ul style="list-style-type: none"> • Width: 3.25" • Height: 3" <p>For 23 Ball & 32 Ball Clutches</p> <p><u>Available Colors:</u> (BK) Black, (BN) Bronze, (SW) Snow White</p> <p>US Patent No 8,967,227B2 Taiwan Patent No M463096 China Patent No CN 203230329U</p>	<p>1 SET / BAG 50 SETS / BOX</p>



ROLLER/ ZEBRA™ SHADE COMPONENTS

All prices are subject to change without notice

FEB 16, 2024

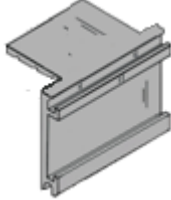
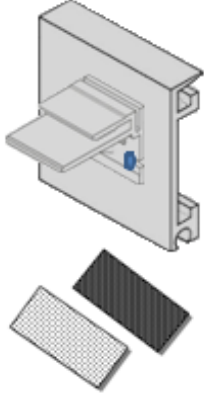
 <p>3</p>	<p>R-IB-F4-NFSB-XX</p>	<p>FASCIA SUPPORT BRACKET FOR 4" FASCIA</p> <p>A 4" wide aluminum support with 1 3/4" top that connects with the fascia's two rails. Double 1" x 1" Notches.</p> <p><u>Available Colors:</u> (BK) Black, (SW) Snow White</p> <p>US Patent No D737,671S US Patent 9,617,785 B2 Taiwan Patent No M475240 Taiwan Patent 495169 & M4991689 Chinese Patent CN 204015899U</p>	<p>6 PCS / BAG</p>
 <p>3</p>	<p>R-IB-FSB-SW</p>	<p>FASCIA SUPPORT BRACKET FOR 3" & 4" FASCIA</p> <p>A 2" wide aluminum support that connects with the rear rails on Genes' two standard fascias for <u>UNI-Face System</u> use.</p> <p>Fascia Support Bracket with attached UNI-Face Clip. Velcro strips are included.</p> <p><u>Available Colors:</u> (SW) Snow White ONLY</p> <p>US Patent No D737,671S US Patent 9,617,785 B2 Taiwan Patent No M475240 Taiwan Patent 495169 & M4991689 Chinese Patent CN 204015899U</p>	<p>10 PCS / BAG</p>

BUTTED BRACKETS (Side by Side Shades)

Main Office: 620 S. Jefferson St. Unit A, Placentia, CA 92870 Tel (800) 441-2024 Fax (800) 787-5369
4570 Shelby Air Dr. Suite 6, Memphis, TN 38118 Tel (901) 360-0058 Fax (901) 365-3007



ROLLER/ ZEBRA™ SHADE COMPONENTS

All prices are subject to change without notice

FEB 16, 2024

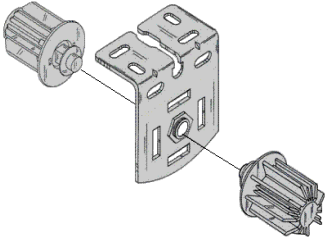
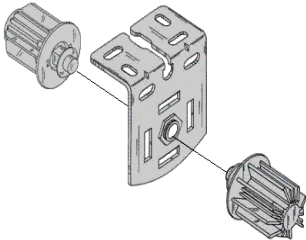
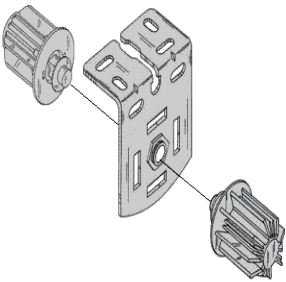
 <p>3</p>	<p>R-IB35-ABGL-XX</p> <p>ZINC</p> <p>BLACK & WHITE</p>	<p>GL ASSEMBLED BUTTED INSTALLATION BRACKET (bracket only) 35.5mm (1 3/8") - From top to center of hole</p> <p>Available Colors: (XX) (BK) Black, (SW) Snow White, (Z) Zinc</p> <p>US Patent # D683565S TW Patent# M467417 & M459810</p>	<p>25 PCS / BAG</p> <p>200 SETS / BOX</p>
 <p>3</p>	<p>R-IB45-ABGL-XX</p> <p>ZINC</p> <p>BLACK</p>	<p>GL ASSEMBLED BUTTED INSTALLATION BRACKET (bracket only) 45.5mm (1 3/4") - From top to center of hole</p> <p>Available Colors: (XX) (BK) Black, (Z) Zinc</p> <p>US Patent # D683565S TW Patent# M467417 & M459810</p>	<p>25 PCS / BAG</p> <p>200 SETS / BOX</p>
 <p>3</p>	<p>Discontinued</p> <p>R-IB55-ABGL-Z</p> <p>ZINC</p>	<p>GL ASSEMBLED BUTTED INSTALLATION BRACKET (bracket only) 55.5mm (2 5/32") - From top to center of hole</p> <p>Available Colors: (Z) Zinc ONLY</p> <p>US Patent # D683565S TW Patent# M467417</p>	<p>25 PCS / BAG</p> <p>200 SETS / BOX</p>



ROLLER/ ZEBRA™ SHADE COMPONENTS

All prices are subject to change without notice

FEB 16, 2024

 <p>3</p>	<p>GEN-IB-M</p>	<p>DUO BUTTED BRACKET</p> <p>U.S. Patent Pending</p>	<p>1 PIECE</p>
---	------------------------	---	-----------------------

CORDLESS MINI & EZ-MATIC BRACKETS

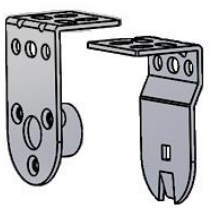
 <p>3</p>	<p>R-IB23-MEZM-T/P-XX</p>	<p>23mm MINI EZ-MATIC (cordless) TENSIONER / POSITIONER BRACKETS</p> <p>23mm to center of hole Maximum 4' x 4' or 3 LBS maximum weight</p> <p><u>Available Color s: (XX)</u> (BK) Black, (SW) Snow White</p>	<p>25 SETS / BAG</p>
 <p>3</p>	<p>R-IB32-MEZM-T/P-XX</p>	<p>32mm MINI EZ-MATIC (cordless) TENSIONER/POSITIONER BRACKETS</p> <p>32mm to center of hole Maximum 4' x 6' or 4 LBS maximum weight</p> <p><u>Available Color s: (XX)</u> (BK) Black, (SW) Snow White</p>	<p>25 SETS / BAG</p>



ROLLER/ ZEBRA™ SHADE COMPONENTS

All prices are subject to change without notice

FEB 16, 2024

 <p>3</p>	<p>R-EZM-IB35S-XX</p>	<p>EZ-MATIC TENSION SQUARE HOLE RETRACTABLE CONTROL BRACKET/TENSIONER BRACKET - 35mm Center Drop</p> <p>Tensioneer, use round key bracket Positioneer, use square hole bracket</p> <p><u>Available Colors: (XX)</u> (BK) Black, (SW) Snow White</p>	<p>10 SET / BAG</p> <p>100 SET / BOX</p>
 <p>3</p>	<p>R-EZM-IB45S-XX</p>	<p>EZ-MATIC TENSION SQUARE HOLE RETRACTABLE CONTROL BRACKET/TENSIONER BRACKET - 45mm Center Drop</p> <p>Tensioneer, use the clover key bracket Positioneer, use the square hole bracket</p> <p><u>Available Color s:</u> (BK) Black, (SW) Snow White,</p>	<p>10 SET / BAG</p> <p>50 SET / BOX</p>
 <p>3</p>	<p>R-EZM-IBBLOCK-XX</p>	<p>EZ-MATIC INSTALLATION BRACKET SUPPORT BLOCK</p> <p>Used with R-EZM-IB35-XX or R-EZM-IB45-XX to keep adjustment wheel free moving</p> <p><u>Available Colors: (XX)</u> (SW) Snow White, (BK) Black</p>	<p>100 PCS/ BAG</p> <p>2,000 PCS/ BOX</p>



REGULAR MOTOR BRACKETS



ROLLER/ ZEBRA™ SHADE COMPONENTS

All prices are subject to change without notice

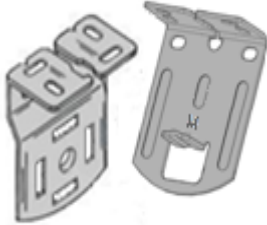
FEB 16, 2024

 <p>3</p>	<p>R-IB35-EZ-M</p> <p>\$1.81/SET</p>	<p>35mm EZ BRACKET FOR BATTERY MOTORS (Stamped with an M)</p> <p>Special Sized Tab to Fit Motors: MRS-M-B-Z & MRS-M25-RB</p> <p>Clutch Prong is 10.5mm</p> <p><u>Available Colors:</u> (Z) Zinc ONLY</p> <p>US Patent No D683,565S Taiwan Patent No M459810</p>	<p>50 SETS / BOX</p> <p>200 SETS / BOX</p>
 <p>3</p>	<p>R-IB45UC-EZ-M-XX</p> <p>Zinc: Color:</p>	<p>45mm EZ BRACKET FOR BATTERY MOTORS (Stamped with an M)</p> <p>Special Sized Tab to Fit Motors: MRS-M-B-Z & MRS-M25-RB</p> <p>Clutch Prong is 9.5 to 10.5mm</p> <p><u>Available Colors:</u> (W) White (Z) Zinc, (BK), Black</p> <p>US Patent No D683,565S Taiwan Patent No M459810</p>	<p>50 SETS / BOX</p>
 <p>3</p>	<p>MRS-IB-MAC-65</p>	<p>SPECIAL 2 5/8" AC MOTOR INSTALLATION BRACKET</p> <ul style="list-style-type: none"> • For AC motorized shades with longer lengths • 65mm drop to center of hole 	<p>1 SET/ BAG</p>



ROLLER/ ZEBRA™ SHADE COMPONENTS

All prices are subject to change without notice

FEB 16, 2024

GENESIS MOTOR BRACKETS

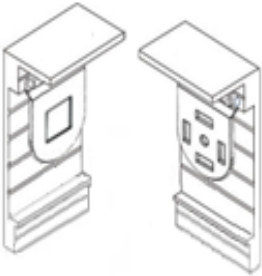
 <p>10.2mm square hole 37mm drop</p> <p>3</p>	<p>GEN-IBM37-M35</p>	<p>HEAVY DUTY GENESIS MOTOR BRACKET (37mm drop) with Mini Mount 35mm For AC Genesis Motor GEN-MOTOR35 & Rechargeable DC Genesis Motor GEN-M35-RB using Genesis 1-5/8" TUBE,</p> <ul style="list-style-type: none"> • Max shade 10FTx 12FT • Max weight 20 lbs. <p><u>AC MOTOR:</u></p> <ul style="list-style-type: none"> • Minimum shade width 21" • Speed 32 rpm. <p><u>DC MOTOR:</u></p> <ul style="list-style-type: none"> • Minimum shade width 25" • Speed 30 rpm <p>Available Color: Snow White ONLY</p>	<p>1 SET/ BAG</p>
---	-----------------------------	--	--------------------------



ROLLER/ ZEBRA™ SHADE COMPONENTS

All prices are subject to change without notice

FEB 16, 2024

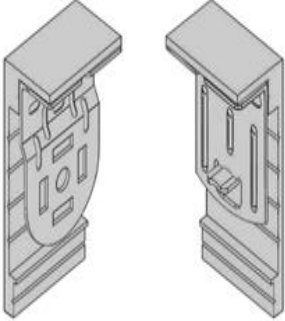
 <p>3</p>	<p>GEN-IB49-M35</p>	<p>HEAVY DUTY GENESIS MOTOR BRACKET (49mm drop) with EZ Roll 23 BALL BRACKET</p> <p>For Genesis AC Motor GEN-MOTOR35 & Rechargeable Genesis DC Motor GEN-M35-RB using Genesis 1-5/8" TUBE Clutch Prong is 12.5mm</p> <ul style="list-style-type: none"> • Max shade 10FT X 12FT • Max weight 16 Lbs. <p><u>AC MOTOR:</u></p> <ul style="list-style-type: none"> • Minimum shade width 21" • Speed 32 rpm. <p><u>DC MOTOR:</u></p> <ul style="list-style-type: none"> • Minimum shade width 25" • Speed 30 rpm <p>Available Color: Snow White ONLY</p>	<p>1 SET/ BAG</p>
---	----------------------------	--	--------------------------



ROLLER/ ZEBRA™ SHADE COMPONENTS

All prices are subject to change without notice

FEB 16, 2024

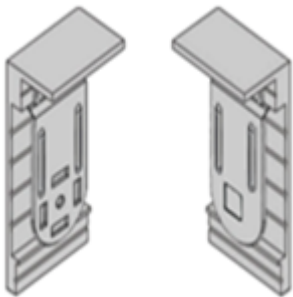
 <p>10.2mm square hole 57mm drop</p> <p>3</p>	<p>GEN-IBM57-M35</p>	<p>HEAVY DUTY GENESIS MOTOR BRACKET (57mm drop) with Mini Mount 55mm</p> <p>For Genesis AC Motor GEN-MOTOR35 and Rechargeable Genesis DC Motor GEN-M35-RB using Genesis 2" TUBE</p> <ul style="list-style-type: none"> • Max shade 12FT X 12FT • Max weight 20 Lbs. <p>AC MOTOR:</p> <ul style="list-style-type: none"> • Minimum shade width 21" • Speed 32 rpm. <p>DC MOTOR:</p> <ul style="list-style-type: none"> • Minimum shade width 25" • Speed 30 rpm <p>Available Color: Snow White ONLY</p>	<p>1 SET/ BAG</p>
---	-----------------------------	---	--------------------------

ZEBRA SHADE™

ADJUSTABLE BRACKETS (Fine tune length at installation)





 <p>3</p>	<p>GEN-IB-AC</p>	<p>ADJUSTABLE ZEBRA BRACKET (For Chain Pulled)</p> <p>Use on UNI-Rail A & UNI-Cassette 2 Lower Clutch Prong is 12.5mm</p> <p>23 Ball (Main) & Mini Clutch (Adjustable)</p> <p>Use 1-5/8" & 3/4" MINI TUBE</p>	<p>1 SET/ BAG</p>
---	-------------------------	--	--------------------------



ROLLER/ ZEBRA™ SHADE COMPONENTS

All prices are subject to change without notice

FEB 16, 2024

 <p>3</p>	<p>GEN-IB-CE</p>	<p>ADJUSTABLE ZEBRA DUO BRACKET (For M25 Motor) Use on UNI-Rail A & UNI-Cassette 2 Lower Clutch Prong is 10.5mm</p> <p>Motor (Main) & Mini Clutch (Adjustable)</p> <p>Use 1-5/8" & 3/4" MINI TUBE</p>	<p>1 SET/ BAG</p>
 <p>3</p>	<p>R-ATSB-S</p>	<p>SUPPORT BRACKET FOR BACK TUBE ADJUSTABLE STANDARD ZEBRA, NOT suitable for UNI-Rail C</p> <p>Plastic Clear</p> <p>U.S. & Foreign Patent Pending</p>	<p>50 PCS /BAG 1,000 / BOX</p>
 <p>3</p>	<p>R-ATSB-R</p>	<p>SUPPORT BRACKET FOR BACK TUBE ADJUSTABLE REVERSE ROLL ZEBRA</p> <p>Use on UNI-Rail C</p> <p>Plastic Clear</p>	<p>50 PCS /BAG 1,000 / BOX</p>
 <p>3</p>	<p>R-ATSB-R2</p>	<p>SUPPORT BRACKET FOR BACK TUBE ADJUSTABLE REVERSE ROLL ZEBRA IN 4" VALANCE & UNI-CASSETTE 2</p> <p>Use on 4" Valance, UNI-Rail A, and UNI-Cassette 2</p> <p>Plastic Clear</p>	<p>50 PCS /BAG 1,000 / BOX</p>



ROLLER/ ZEBRA™ SHADE COMPONENTS

All prices are subject to change without notice

FEB 16, 2024

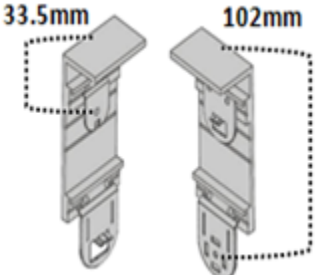
 <p>3</p>	<p>R-ATSB-R3</p>	<p>SUPPORT BRACKET FOR BACK TUBE OF ADJUSTABLE ZEBRA</p> <p>Used on Heavy Duty adjustable Zebra brackets R-IB23D-ADJZ-XX & R-IB23D-ADJZ-XX when width exceeds 72"</p> <p>Plastic Clear</p> <p>U.S. & Foreign Patent Pending</p>	<p>50 PCS /BAG 1,000 / BOX</p>
 <p>3</p> <p>Top to center of hole</p>	<p>R-IB23D-ADJZ-SW</p>	<p>ADJUSTABLE ZEBRA BRACKET (Heavy Duty) - 50mm wide</p> <p>23 Ball Clutch (Lower Main) & Mini Clutch for (Upper Adjustable)</p> <p>Lower Clutch Prong is 12.5mm</p> <p>Uses 1-5/8" Main Tube & 3/4" Adjustable MINI TUBE</p> <p>Over 72" width use with R-ATSB-3</p> <p>Available in Snow White ONLY</p> <p>US Patent No 8,967,227B2 US Patent No D721,243S Taiwan Patent No M463096 China Patent No CN 203230329U</p>	<p>1 SET/ BAG</p>



ROLLER/ ZEBRA™ SHADE COMPONENTS

All prices are subject to change without notice

FEB 16, 2024

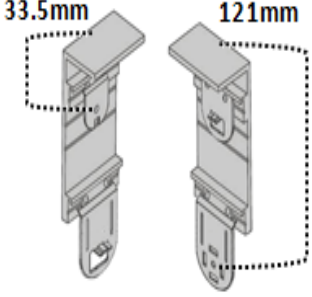
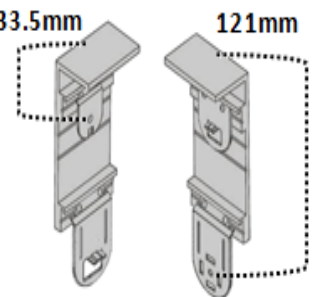
<p>Top to center of hole</p>  <p>3</p>	<p>R-IB23LD-ADJZ-XX</p>	<p>ADJUSTABLE ZEBRA BRACKET (Heavy Duty) - 50mm wide</p> <p>23 Ball Clutch (Longer Lower Main) & Mini Clutch for (Upper Adjustable)</p> <p>Lower Clutch Prong is 12.5mm</p> <p>Use 2" Main Tube & 3/4" Adjustable MINI TUBE</p> <p>Over 72" width use with R-ATSB-3</p> <p>Available in Snow White ONLY</p> <p>US Patent No 8,967,227B2 US Patent No D721,243S Taiwan Patent No M463096 China Patent No CN 203230329U</p>	<p>1 SET/ BAG</p>
<p>Top to center of hole</p>  <p>3</p>	<p>R-IB32D-ADJZ-SW</p>	<p>ADJUSTABLE ZEBRA BRACKET (Heavy Duty) - 50mm wide</p> <p>32 Ball Clutch (Lower Main) & Mini Clutch for (Upper Adjustable)</p> <p>Lower Clutch Prong is 13.5mm</p> <p>Use 2" Main Tube & 3/4" Adjustable MINI TUBE</p> <p>Over 72" width use with R-ATSB-3</p> <p>Available in Snow White ONLY</p> <p>US Patent No 8,967,227B2 US Patent No D721,243S Taiwan Patent No M463096 China Patent No CN 203230329U</p>	<p>1 SET/ BAG</p>



ROLLER/ ZEBRA™ SHADE COMPONENTS

All prices are subject to change without notice

FEB 16, 2024

STANDARD DUO BRACKETS

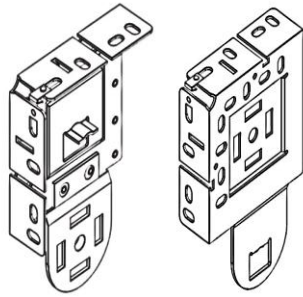
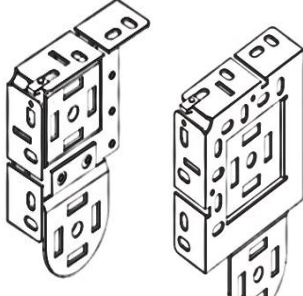
 <p>3</p>	<p>R-IB23D-S-EZ-XX</p>	<p>** NEW 2020** EZ VERTICAL DUO SHADE INSTALLATION BRACKET - <i>SHORT</i>, 4.5" total length Square 2 3/4" x 2 3/4",</p> <p>Only For 23 Ball Clutches Clutch Prong is 12.5mm</p> <p><u>Available Colors:</u> (BK) Black, (SW) Snow White</p> <p>US Patent No 8,967,227B2 US Patent No D721,243S Taiwan Patent No M463096 China Patent No CN 203230329U</p>	<p>1 SET / BAG</p>
 <p>3</p>	<p>R-IB23D-S-GL-XX</p>	<p>** NEW 2020 ** GL VERTICAL DUO SHADE INSTALLATION BRACKET - <i>SHORT</i>, 4.5" total length Square 2 3/4" x 2 3/4",</p> <p>Only For 23 Ball Clutches</p> <p><u>Available Colors:</u> (BK) Black, (SW) Snow White</p> <p>US Patent No 8,967,227B2 US Patent No D721,243S Taiwan Patent No M463096 China Patent No CN 203230329U</p>	<p>1 SET / BAG</p>



ROLLER/ ZEBRA™ SHADE COMPONENTS

All prices are subject to change without notice

FEB 16, 2024

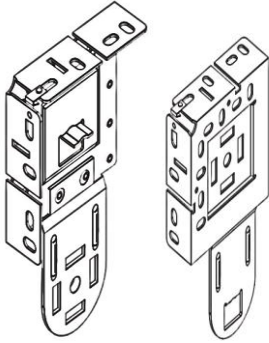
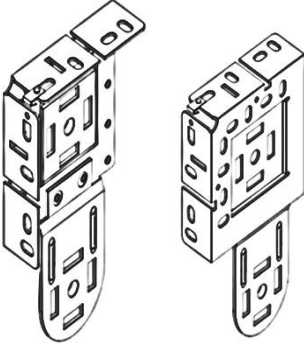
 <p>3</p>	<p>R-IB23D-L-EZ-XX</p>	<p>** NEW 2020** EZ VERTICAL DUO SHADE INSTALLATION BRACKET, LONG, 5" total length Square 2 3/4" x 2 3/4"</p> <p>Only For 23 Ball Clutches Clutch Prong is 12.5mm</p> <p><u>Available Colors:</u> (BK) Black, (SW) Snow White</p> <p>US Patent No 8,967,227B2 US Patent No D721,243S Taiwan Patent No M463096 China Patent No CN 203230329U</p>	<p>1 SET / BAG</p>
 <p>3</p>	<p>R-IB23D-L-GL-XX</p>	<p>** NEW 2020** GL VERTICAL DUO SHADE INSTALLATION BRACKET, LONG, 5" total length Square 2 3/4" x 2 3/4"</p> <p>Only For 23 Ball Clutches</p> <p><u>Available Colors:</u> (BK) Black, (BN) Bronze, (SW) Snow White</p> <p>US Patent No 8,967,227B2 US Patent No D721,243S Taiwan Patent No M463096 China Patent No CN 203230329U</p>	<p>1 SET / BAG</p>



ROLLER/ ZEBRA™ SHADE COMPONENTS

All prices are subject to change without notice

FEB 16, 2024

<p style="text-align: center;">NEW</p>  <p style="text-align: center;">3</p>	<p style="text-align: center;">R-IB23D2-EZ-XX</p>	<p>** NEW 2020** EZ VERTICAL DUO SHADE INSTALLATION BRACKET, 5 1/2" total length Square 3 1/8" x 3 1/8"</p> <p>Only For 23 Ball Clutches Clutch Prong is 12.5mm Opposite Clutch Positions</p> <p><u>Available Colors:</u> (BK) Black, (SW) Snow White</p> <p>US Patent No 8,967,227B2 US Patent No D721,243S Taiwan Patent No M463096</p>	<p style="text-align: center;">1 SET / BAG</p>
<p style="text-align: center;">NEW</p>  <p style="text-align: center;">3</p>	<p style="text-align: center;">R-IB32D2-EZ-XX</p>	<p>** NEW 2020** EZ VERTICAL DUO SHADE INSTALLATION BRACKET, 5 1/2" total length Square 3 1/8" x 3 1/8"</p> <p>Only For 32 Ball Clutches Clutch Prong is 13.5mm Opposite Clutch Positions</p> <p><u>Available Colors:</u> (BK) Black, (SW) Snow White</p> <p>US Patent No 8,967,227B2 US Patent No D721,243S Taiwan Patent No M463096</p>	<p style="text-align: center;">1 SET / BAG</p>



ROLLER/ ZEBRA™ SHADE COMPONENTS

All prices are subject to change without notice

FEB 16, 2024

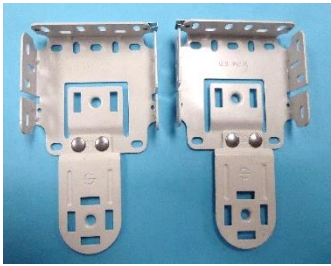
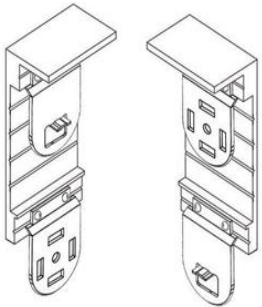
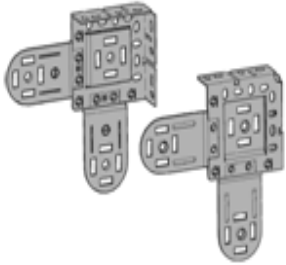
<p>NEW</p>  <p>3</p>	<p>R-IB32D2-GL-XX</p>	<p>** NEW 2020** GL VERTICAL DUO SHADE INSTALLATION BRACKET, 5 1/2" total length Square 3 1/8" x 3 1/8"</p> <p>Only For 32 Ball Clutches Opposite Clutch Positions</p> <p><u>Available Colors:</u> (BK) Black, (SW) Snow White</p> <p>US Patent No 8,967,227B2 US Patent No D721,243S Taiwan Patent No M463096</p>	<p>1 SET / BAG</p>
 <p>3</p>	<p>R-IB23DHD-EZ-SW</p>	<p>HEAVY DUTY DUO BRACKETS FOR 23 BALL EZ Roll</p> <p>Clutch Prong is 12.5mm</p> <p>Use on 8 to 10 Lbs (Clutch)</p> <p>Use 1-5/8" TUBE to Uni- Cassette 2 with SN-O2 (Screw & Nut) Available in Snow White ONLY</p> <p>Max shade 8' x 8', Max weight 10 lbs. Spring Assist Max weight 16 lbs.</p>	<p>1 SET/ BAG</p>
 <p>3</p>	<p>DISCONTINUED</p> <p>R-IB32D-GL-XX</p>	<p>GL DUO SHADE INSTALLATION BRACKET For 32 Ball Clutches - Square 2 3/4" x 2 3/4" (Two shades on outer mounts)</p> <p><u>Available Colors:</u> (BK) Black, (BN) Bronze</p> <p>US Patent No 8,967,227B2 US Patent No D721,243S Taiwan Patent No M463096 China Patent No CN 203230329U</p>	<p>1 SET / BAG 50 SETS / BOX</p>

Main Office: 620 S. Jefferson St. Unit A, Placentia, CA 92870 Tel (800) 441-2024 Fax (800) 787-5369
4570 Shelby Air Dr. Suite 6, Memphis, TN 38118 Tel (901) 360-0058 Fax (901) 365-3007



ROLLER/ ZEBRA™ SHADE COMPONENTS

All prices are subject to change without notice

FEB 16, 2024

EZ-MATIC (cordless) DUO MINI & MINI BRACKET

 <p>3</p>	<p>GEN-IB-HI</p>	<p>MINI DUO BRACKET (For Chain Pulled)</p> <p>Use on UNI-Rail A & UNI-Cassette 2</p> <p>(Both are Mini Shades)</p> <p>Both use 3/4" MINI TUBE</p> <p>Up to 5 lbs weight on each shade</p>	<p>1 SET/ BAG</p>
 <p>3</p>	<p>GEN-IB-JL</p>	<p>MINI-MATIC LOWER & UPPER W/POSITIONEER (Square Hole 4.2 mm) DUO BRACKET (For Mini Cordless)</p> <p>Use on UNI-Rail A & UNI-Cassette 2</p> <p>Both use 3/4" MINI TUBE</p> <p>Up to 5 lbs weight on each shade</p>	<p>1 SET/ BAG</p>
 <p>3</p>	<p>GEN-IB-JK</p>	<p>MINI-MATIC LOWER & UPPER W/NO POSITIONEER (Round Hole 5.2 mm) DUO BRACKET (For Mini Cordless)</p> <p>Use on UNI-Rail A & UNI-Cassette 2</p> <p>Both use 3/4" MINI TUBE</p> <p>Up to 5 lbs weight on each shade</p>	<p>1 SET/ BAG</p>



EZ-MATIC (Cordless) DUO BRACKETS



ROLLER/ ZEBRA™ SHADE COMPONENTS

All prices are subject to change without notice

FEB 16, 2024

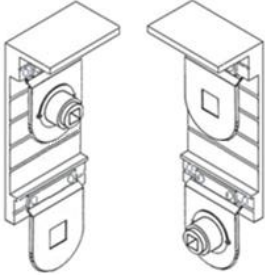
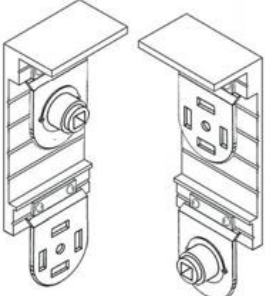
 <p>3</p>	<p>GEN-IB-BD</p>	<p>EZ-MATIC LOWER with POSITIONEER & MINI UPPER DUO BRACKET</p> <p>Use with 1-5/8" and 3/4" Mini Tube</p> <p>U.S. Patent Pending</p>	<p>1 SET</p>
 <p>3</p>	<p>GEN-IB-BC</p>	<p>EZ-MATIC LOWER with NO POSITIONEER (Round Hole) & MINI UPPER DUO BRACKET</p> <p>Use with 1-5/8" & 3/4" Mini Tube</p> <p>U.S. Patent Pending</p>	<p>1 SET</p>
 <p>3</p>	<p>R-EZMTP-IB23DHD-SW</p>	<p>EZ-MATIC Duo with TENSIONEER/POSITIONEER</p> <p>Use 1- 5/8" TUBE on Uni- Cassette 2 with SN-O2 (Screw & Nut)</p> <p>Max shade 8' x 8', Max weight 10 lbs.</p> <p>Available in Snow White ONLY</p>	<p>1 SET/ BAG</p>
 <p>3</p>	<p>R-EZMT-IB23DHD-SW</p>	<p>EZ-MATIC Duo with NO POSITIONEER</p> <p>Use 1- 5/8" TUBE on Uni- Cassette 2 with SN-O2 (Screw & Nut)</p> <p>Max shade 8' x 8', Max weight 10 lbs.</p> <p>Available in Snow White ONLY</p>	<p>1 SET/ BAG</p>



ROLLER/ ZEBRA™ SHADE COMPONENTS

All prices are subject to change without notice

FEB 16, 2024

GENESIS MOTORS HEAVY DUTY DUO BRACKETS

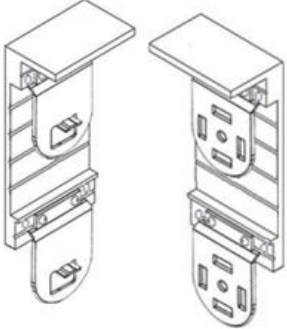
 <p>3</p>	<p>GEN-IBM23D-M35-L</p>	<p>GENESIS MOTOR DUO BRACKETS - Less than 10 Lbs</p> <p>EZ Roll Duo Bracket (set) for AC Genesis Motor GEN-MOTOR35 & Rechargeable DC Genesis Motor GEN-M35-RB Clutch Prong is 12.5mm</p> <p>Use Genesis 1- 5/8" TUBE, can be attached to Uni- Cassette 2 with SN-02 (Screw & Nut).</p> <p>Max AC motor shade 10' X 12', Minimum shade width 21", Max weight 10 lbs., Speed 32 rpm.</p> <p>Max DC motor shade 10' x 12', Minimum shade width 25", Max weight 10 lbs., Speed 30 rpm.</p> <p>Available Color: Snow White ONLY</p>	<p>1 SET/ BAG</p>
---	--------------------------------	---	--------------------------



ROLLER/ ZEBRA™ SHADE COMPONENTS

All prices are subject to change without notice

FEB 16, 2024

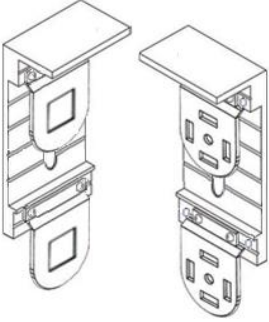
 <p>10.2mm square hole 37mm drop</p> <p>3</p>	<p>GEN-IBM23D-M35-H</p>	<p>GENESIS MOTOR DUO BRACKETS - <u>More than 10 Lbs.</u></p> <p>EZ Roll Duo Bracket (set) for AC Genesis Motor GEN-MOTOR35 and Rechargeable DC Genesis Motor GEN-M35-RB</p> <p>Use Genesis 1- 5/8" TUBE, can be attached to Uni- Cassette 2 with SN-02 (Screw & Nut).</p> <ul style="list-style-type: none"> • Max shade 10FT X 12FT • Max weight 20 Lbs. <p><u>AC MOTOR:</u></p> <ul style="list-style-type: none"> • Minimum shade width 21" • Speed 32 rpm. <p><u>DC MOTOR:</u></p> <ul style="list-style-type: none"> • Minimum shade width 25" • Speed 30 rpm <p>Available Color: Snow White ONLY</p>	<p>1 SET/ BAG</p>
---	--------------------------------	--	--------------------------

CORDS & CHAINS 4

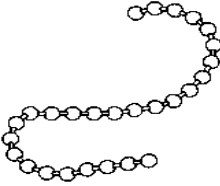

 <p>4</p>	<p>BC-10S</p>	<p>#10 NICKEL PLATED STEEL (N.P.S.) BALL CHAIN</p> <p>Diameter 4.45mm (.1752")</p> <p>48-49 BALLS / FT</p>	<p>500 FT / ROLL</p> <p>4 ROLLS / BOX</p>
---	----------------------	---	---



ROLLER/ ZEBRA™ SHADE COMPONENTS

All prices are subject to change without notice

FEB 16, 2024

 <p>4</p>	<p>BC-10PXX-D</p>	<p>#10 PLASTIC BALL CHAIN (DOUBLE)</p> <p>Diameter 4.3mm (.1693") 50 Balls/FT,</p> <p><u>Available Colors : (XX)</u> (B) Black, (BN) Brown (Discontinued), (C) Clear, (G) Grey, (I) Ivory, (W) White PB</p>	<p>656FT/ROLL</p>
 <p>4</p>	<p>BC-13P-XX</p>	<p>#13 EZ GRIP PLASTIC BALL CHAIN</p> <p>100 meters (328 ft) per roll 36 balls per foot</p> <p><u>Available Colors:(XX)</u> (CH) Cherry, (GE) Grey, (MA) Mahogany, (SW) Snow White</p>	<p>4 ROLLS / BOX</p>
 <p>4</p>	<p>R-PC-CL24-XX</p> <p>R-PC-CL36-XX</p> <p>R-PC-CL48-XX</p> <p>R-PC-CL60-XX</p>	<p>CONTINUOUS 3.0mm POLYCORD LOOP</p> <p><u>Available Loop Drop Size:</u> (24) Drop 24 inches (36) Drop 36 inches (48) Drop 48 inches (60) Drop 60 inches</p> <p><u>Available Colors: (XX)</u> (BK) Black, (BN) Brown, (SW) Snow White</p>	<p>5 PCS / BAG</p>



ROLLER/ ZEBRA™ SHADE COMPONENTS

All prices are subject to change without notice

FEB 16, 2024

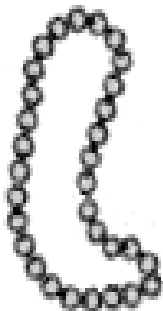



 <p>4</p>	<p>R-PC3.8-CL24-XX R-PC3.8-CL36-XX R-PC3.8-CL48-XX R-PC3.8-CL60-XX R-PC3.8-CL72-XX R-PC3.8-CL84-XX</p>	<p>CONTINUOUS 3.8mm POLYCORD LOOP Thicker for tighter clutch grip</p> <p><u>Available Loop Drop Size:</u> (24) Drop 24 inches (36) Drop 36 inches (48) Drop 48 inches (60) Drop 60 inches (72) Drop 72 inches (84) Drop 84 inches</p> <p><u>Available Colors:(XX)</u> (CH) Cherry, (GE) Grey, (MA) Mahogany, (SW) Snow White</p>	<p>5 PCS / BAG</p>
 <p>4</p>	<p>R-BC-CL24-XX R-BC-CL36-XX R-BC-CL48-XX R-BC-CL60-XX R-BC-CL72-XX</p>	<p>#10 CONTINUOUS LOOP PLASTIC BALL CHAIN</p> <p>DISCONTINUED</p> <p><u>Available Loop Drop Size:</u> (24) Drop 24 inches (36) Drop 36 inches (48) Drop 48 inches (60) Drop 60 inches (72) Drop 72 inches</p> <p><u>Available Colors:(XX)</u> (BK) Black, (BN) Brown, (SW) Snow White</p>	<p>50 PCS / BAG</p>



ROLLER/ ZEBRA™ SHADE COMPONENTS

All prices are subject to change without notice

FEB 16, 2024



 <p>4</p>	<p>R-BC13-CL24-XX R-BC13-CL36-XX R-BC13-CL48-XX R-BC13-CL60-XX R-BC13-CL72-XX R-BC13-CL84-XX</p>	<p>#13 EZ GRIP CONTINUOUS LOOP PLASTIC BALL CHAIN</p> <p><u>Available Loop Drop Size:</u> (24) Drop 24 inches (36) Drop 36 inches (48) Drop 48 inches (60) Drop 60 inches (72) Drop 72 inches (84) Drop 84 inches</p> <p><u>Available Colors:(XX)</u> (CH) Cherry, (GE) Grey, (MA) Mahogany, (SW) Snow White</p>	<p>50 PCS / BAG</p>
 <p>4</p>	<p>R-M-SB7.9</p>	<p>CLEAR PLASTIC STOP BALL</p> <p>For BC-10S #10 N.P.S. Ball chain & BC-10P Plastic Ball chain</p> <ul style="list-style-type: none"> ● 7.9mm ball for Slim Swivel Head Safety Lock 	<p>1,000 PCS / BAG</p>
 <p>4</p>	<p>R-M-SB</p>	<p>CLEAR PLASTIC STOP BALL</p> <p>For BC-10S #10 N.P.S. Ball chain & BC-10P Plastic Ball chain</p> <ul style="list-style-type: none"> ● 8.7mm ball 	<p>1,000 PCS / BAG</p>
 <p>4</p>	<p>R-M-SB13</p>	<p>CLEAR PLASTIC STOP BALL</p> <p>For #13 Plastic Ball chain-</p>	<p>500 PCS / BAG</p>



ROLLER/ ZEBRA™ SHADE COMPONENTS

All prices are subject to change without notice

FEB 16, 2024

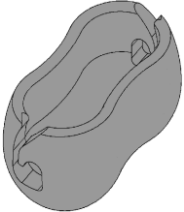
 <p>4</p>	<p>OB-15</p>	<p>OPEN BEAD (as a stop ball)</p> <ul style="list-style-type: none"> Nickel Plated Steel #15, diameter 5/16" 	<p>1,000 PCS / BAG</p>
 <p>4</p>	<p>C-10 (BRASS)</p> <p>ENAMELED COLOR C-10-XX</p>	<p>METAL #10 CHAIN CONNECTOR</p> <p>Metal #10 connector for plastic chains Use on shades over 5 lbs.</p> <p>Nickel Plated & Acid Etched Enamelled Colors</p> <p><u>Available Colors : (XX)</u> (SW) Snow White Enamel, (BK) Black Enamel, (SI) Nickel Plated Brass</p>	<p>SILVER METAL 1,000/BAG</p> <p>ENAMELED 500/BAG</p>
 <p>4</p>	<p>C-13 (BRASS)</p>	<p>METAL #13 N.P.B. CHAIN CONNECTOR</p> <p>Metal #13 connector for plastic chains Use on shades over 5 lbs.</p> <p>Nickel Plated</p>	<p>SILVER METAL 500/BAG</p>
 <p>4</p>	<p>R-M-PC10S-XX</p> <p><u>CLEAR</u></p> <p><u>COLOR</u></p>	<p>#10 PLASTIC CHAIN <u>SLIM</u> CONNECTOR</p> <p>Also can be used as stop ball on #10 chain</p> <p>Required for chain on Slim Swivel Head Safety Lock</p> <p>Holds up to 5 lbs.</p> <p><u>Available Discontinue Colors (XX)</u> (BK) Black, (BN) Brown, (C) Clear (SW) Snow White</p>	<p>500 PCS / BAG</p>



ROLLER/ ZEBRA™ SHADE COMPONENTS

All prices are subject to change without notice

FEB 16, 2024

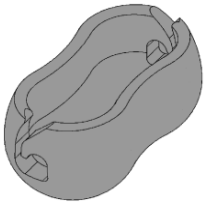
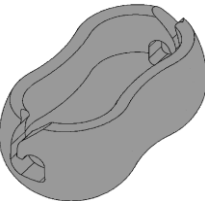
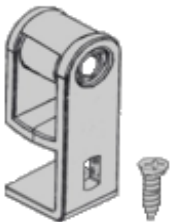

 <p>4</p>	<p>R-M-PC10-XX</p> <p>(COLOR)</p>	<p>#10 PLASTIC CHAIN CONNECTOR</p> <p>Also can be used as stop ball on #10 chain</p> <p>Holds up to 8 lbs.</p> <p><u>Available Colors</u> : (XX) (BK) Black, (C) Clear (SW) Snow White</p>	<p>500 PCS / BAG</p>
 <p>4</p>	<p>R-M-PC13-XX</p>	<p>#13 PLASTIC PEANUT CHAIN CONNECTOR</p> <p>Also can be used as stop ball on #10 chain</p> <p>Holds up to 12 lbs.</p> <p><u>Available Colors</u> : (XX) (BK) Black, (C) Clear , (SW) Snow White</p>	<p>500 PCS / BAG</p>
 <p>*SCREW INCLUDED</p> <p>4</p>	<p>R-SR-U-XX</p>	<p>UNIVERSAL SAFE GUARD RETAINER WITH ROLLER</p> <p>*SCREW INCLUDED -3 x14.5mm Oval Philip head</p> <p>Used on all sprockets with chain or continuous cord loop</p> <ul style="list-style-type: none"> • Height: 2" • Width: 5/8" <p><u>Available Colors</u> (XX) (BN) Brown, (C) Clear, (SW) Snow White</p> <p>*US Patent No. D591933S*</p>	<p>500 SETS / BAG</p> <p>2,000SETS/BOX</p>



ROLLER/ ZEBRA™ SHADE COMPONENTS

All prices are subject to change without notice

FEB 16, 2024



 <p>4</p>	<p>R-SRE-U-XX</p>	<p>SAFE GUARD RETAINER EXTENSION Use with Universal Safe Guard Retainer</p> <p><u>Available Colors</u> :(XX) (BN) Brown, (C) Clear, (SW) Snow White</p>	<p>500 PCS / BAG 500 PCS / BIG BAG</p>
 <p>CHAIN ONLY</p> <p>4</p>	<p>R-SSL-CH-U-XX</p>	<p>SLIM SWIVEL HEAD SAFETY LOCK 1-1/4"</p> <p>Requires screw R-SW-SR2 Sold Separately</p> <p>Use on all sprockets with chain or continuous chain loop. Use the R-M-SB-S7.9 (Stop Ball) & on chains or Metal Connector (C-10) only</p> <p>Height: 2", Width: 1/2"</p> <p><u>Available Colors</u> :(XX) (BK) Black, (BN) Brown (C) Clear (SW) Snow White</p> <p>* China Patent CN 203802214U * Taiwan Patent M480964</p>	<p>100 PCS / BAG</p>



ROLLER/ ZEBRA™ SHADE COMPONENTS

All prices are subject to change without notice

FEB 16, 2024

 <p>CORD ONLY</p> <p>4</p>	<p>R-SSL-CD-U-XX</p>	<p>SLIM SWIVEL HEAD SAFETY LOCK 1-1/4"</p> <p>Requires screw R-SW-SR2 Sold Separately</p> <p>Used on all sprockets with continuous cord loop. Requires</p> <p>Height: 2" Width: 1/2"</p> <p><u>Available Colors:</u> (XX) (BK) Black, (BN) Brown(C) Clear (SW) Snow White,</p> <p>* China Patent CN 203802214U * Taiwan Patent M480964</p>	<p>100 PCS / BAG</p>
 <p>4</p>	<p>R-SLE-U-XX</p>	<p>SLIM SAFETY LOCK EXTENDER Requires screw R-SW-SRE2</p> <p>Used with both the chain or cord safety lock for extra clearance,</p> <p>* SCREW SOLD SEPARATELY</p> <p><u>Available Colors:</u></p> <p>(BK) Black (BN) Brown, (C) Clear (SW) Snow White,</p> <p>* China Patent CN 203802214U * Taiwan Patent 480964</p>	<p>100 PCS / BAG 5,000 PCS/ BOX</p>

CLUTCHES 5

Main Office: 620 S. Jefferson St. Unit A, Placentia, CA 92870 Tel (800) 441-2024 Fax (800) 787-5369
4570 Shelby Air Dr. Suite 6, Memphis, TN 38118 Tel (901) 360-0058 Fax (901) 365-3007



ROLLER/ ZEBRA™ SHADE COMPONENTS

All prices are subject to change without notice

FEB 16, 2024

MINI CLUTCHES

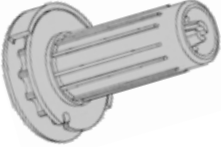
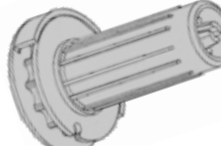
 <p>5</p>	<p>R-CL3-MEZ-XX</p>	<p>MINI EZ SHADE CLUTCH for ¾" MINI TUBE</p> <p>Holds Up to 3 LBS, 13 Balls</p> <p>Use with Mini EZ & with UNI-Rail-Zebra as optional back fabric adjuster</p> <p><u>Available Color s: (XX)</u> (BK) Black, (SW) Snow White</p> <p>US Patent No. D6300086S China Patent CN201248601Y & CN 201248601Y Taiwan Patent No. M440739</p>	<p>50 PCS / BAG</p> <p>100 PCS / BOX</p>
<p>** NEW 2018 **</p>  <p>5</p>	<p>R-CL5-MEZ-XX</p>	<p>MINI EZ SHADE CLUTCH for ¾" MINI TUBE</p> <p>Holds Up to 5 LBS, 13 Balls</p> <p>Use with Mini EZ & with UNI-Rail-Zebra as optional back fabric adjuster</p> <p><u>Available Color s: (XX)</u> (BK) Black, (SW) Snow White</p> <p>US Patent No. D6300086S China Patent CN201248601Y & CN 201248601Y Taiwan Patent No. M440739</p>	<p>50 PCS / BAG</p> <p>100 PCS / BOX</p>



ROLLER/ ZEBRA™ SHADE COMPONENTS

All prices are subject to change without notice

FEB 16, 2024

EZ ROLL (Sits on bracket's tab) & GUIDELINE (Hooks on bracket) CLUTCHES

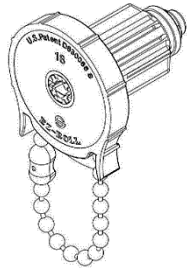
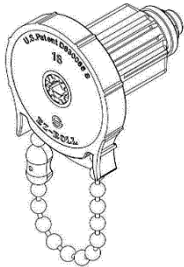
<p>NEW 2022</p>  <p>5</p>	<p>R-CL5-EZ18-XX</p>	<p>18 BALL EZ ROLL 5 LB. CLUTCH FOR 1-5/8" TUBE</p> <p>EZ Roll Only, 12.5mm clutch prong Holds up to 5 lbs, Max Size 4' x 5', 20 sq. ft. Uses #13 EZ Grip Plastic Ball Chain or 3.8mm cord</p> <p><u>Available Colors: (XX)</u> (BK) Black, (SW) Snow White</p> <p>US Patent No. D6300086S China Patent CN201248601Y & CN 201248601Y Taiwan Patent No. M440739</p>	<p>10 PCS / BAG</p> <p>100 PCS / BOX</p>
 <p>NEW 2022</p> <p>5</p>	<p>R-CL8-EZ18-XX</p>	<p>18 BALL EZ ROLL 8 LB. CLUTCH FOR 1-5/8" TUBE</p> <p>EZ Roll Only, 12.5mm clutch prong Holds up to 8 lbs, Max Size 6' x 7', 42 sq. ft. Uses #13 EZ Grip Plastic Ball Chain or 3.8mm cord Deductions same as 32 Ball</p> <p><u>Available Colors: (XX)</u> (BK) Black, (SW) Snow White</p> <p>US Patent No. D6300086S China Patent CN201248601Y & CN 201248601Y Taiwan Patent No. M440739</p>	<p>10 PCS / BAG</p> <p>100 PCS / BOX</p>



ROLLER/ ZEBRA™ SHADE COMPONENTS

All prices are subject to change without notice

FEB 16, 2024

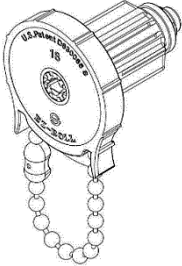
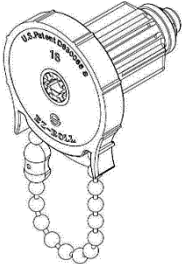
<p>NEW 2022</p>  <p>5</p>	<p>R-CL10-EZ18-XX</p>	<p>18 BALL EZ ROLL 10 LB. CLUTCH FOR 1-5/8" TUBE</p> <p>EZ Roll Only, 12.5mm clutch prong Holds up to 10 lbs, Max Size 7' x 8', 56 sq. ft. Uses #13 EZ Grip Plastic Ball Chain or 3.8mm cord Deductions same as 32 Ball</p> <p><u>Available Colors: (XX)</u> (BK) Black, (SW) Snow White</p> <p>US Patent No. D6300086S China Patent CN201248601Y & CN 201248601Y Taiwan Patent No. M440739</p>	<p>10 PCS / BAG</p> <p>100 PCS / BOX</p>
 <p>NEW 2022</p> <p>5</p>	<p>R-CL12-EZ18-XX</p>	<p>18 BALL EZ ROLL 12 LB. CLUTCH FOR 1-5/8" TUBE</p> <p>EZ Roll Only, 12.5mm clutch prong Holds up to 12 lbs, Max Size 8' x 8', 64 sq. ft. Uses #13 EZ Grip Plastic Ball Chain or 3.8mm cord Deductions same as 32 Ball</p> <p><u>Available Colors: (XX)</u> (BK) Black, (SW) Snow White</p> <p>US Patent No. D6300086S China Patent CN201248601Y & CN 201248601Y Taiwan Patent No. M440739</p>	<p>10 PCS / BAG</p> <p>100 PCS / BOX</p>



ROLLER/ ZEBRA™ SHADE COMPONENTS

All prices are subject to change without notice

FEB 16, 2024

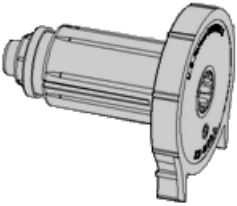
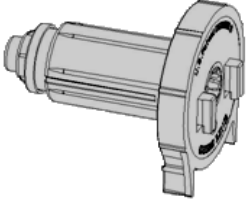
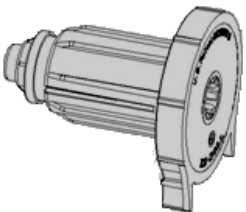
 <p>5</p>	<p>R-CL5-EZ-XX</p>	<p>EZ ROLL CLUTCH FOR 1-1/4" TUBE</p> <p>Holds up to 5 lbs, 23 Balls</p> <p><u>Available Colors: (XX)</u> (BK) Black, (SW) Snow White</p> <p>US Patent No. D6300086S China Patent CN201248601Y & CN 201248601Y Taiwan Patent No. M440739</p>	<p>50 PCS / BAG</p> <p>100 PCS / BOX</p>
 <p>5 DISCONTINUED</p>	<p>Discontinued</p> <p>R-CL5-GL-XX</p>	<p>GUIDELINE CLUTCH FOR 1-1/4" TUBE</p> <p>Holds up to 5 lbs, 23 Balls</p> <p><u>Available Colors: (XX)</u> (BK) Black</p> <p>US Patent No. D6300086S China Patent CN201248601Y & CN 201248601Y Taiwan Patent No. M440739</p>	<p>50 PCS / BAG</p> <p>100 PCS / BOX</p>
 <p>5</p>	<p>R-CL8-EZ-XX</p>	<p>EZ ROLL CLUTCH FOR 1- 1/4" TUBE</p> <p>Holds up to 8 lbs, 23 Balls</p> <p><u>Available Colors: (XX)</u> (BK) Black, (SW) Snow White</p> <p>US Patent No. D6300086S China Patent CN201248601Y & CN 201248601Y Taiwan Patent No. M440739</p>	<p>50 PCS / BAG</p> <p>100 PCS / BOX</p>



ROLLER/ ZEBRA™ SHADE COMPONENTS

All prices are subject to change without notice

FEB 16, 2024

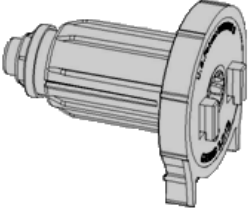
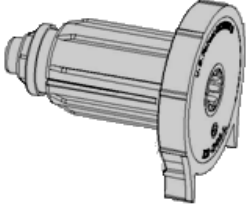
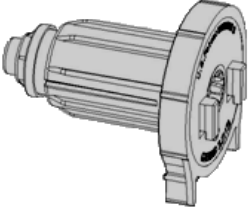
 <p>5 DISCONTINUED</p>	<p>Discontinued R-CL8-GL-XX</p>	<p>GUIDELINE CLUTCH FOR 1-1/4" TUBE</p> <p>Holds up to 8 lbs, 23 Balls</p> <ul style="list-style-type: none"> Suitable for Zebras <p><u>Available Colors: (XX)</u> (BK) Black, (SW) Snow White</p> <p>US Patent No. D6300086S China Patent CN201248601Y & CN 201248601Y Taiwan Patent No. M440739</p>	<p>50 PCS / BAG 100 PCS / BOX</p>
 <p>5</p>	<p>R-CL8-1.5-EZ-XX</p>	<p>EZ ROLL CLUTCH FOR 1-5/8" TUBE</p> <p>Holds up to 8 lbs, 23 Balls</p> <p><u>Available Colors: (XX)</u> (BK) Black, (SW) Snow White</p> <p>US Patent No. D6300086S China Patent CN201248601Y & CN 201248601Y Taiwan Patent No. M440739</p>	<p>50 PCS / BAG 100 PCS / BOX</p>
 <p>5 DISCONTINUED</p>	<p>Discontinued R-CL8-1.5-GL-XX</p>	<p>GUIDELINE CLUTCH FOR 1-5/8" TUBE</p> <p>Holds up to 8 lbs, 23 Balls</p> <ul style="list-style-type: none"> Suitable for Zebras <p><u>Available Colors: (XX)</u> (BK) Black, (SW) Snow White</p> <p>US Patent No. D6300086S China Patent CN201248601Y & CN 201248601Y Taiwan Patent No. M440739</p>	<p>50 PCS / BAG 100 PCS / BOX</p>



ROLLER/ ZEBRA™ SHADE COMPONENTS

All prices are subject to change without notice

FEB 16, 2024

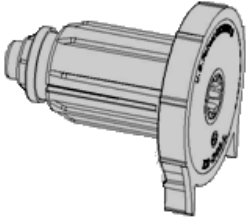
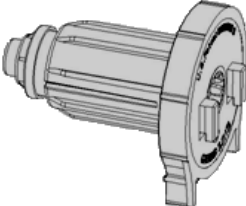
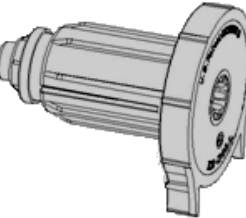
 <p>5</p>	<p>R-CL10-1.5-EZ-XX</p>	<p>EZ ROLL CLUTCH FOR 1-5/8" TUBE</p> <p>Holds up to 10 lbs, 23 Balls</p> <p><u>Available Colors: (XX)</u> (BK) Black, (SW) Snow White</p> <p>US Patent No. D6300086S China Patent CN201248601Y & CN 201248601Y Taiwan Patent No. M440739</p>	<p>50 PCS / BAG</p> <p>100 PCS / BOX</p>
 <p>5 DISCONTINUED</p>	<p>R-CL10-1.5-GL-XX</p>	<p>GL CLUTCH FOR 1 1/2" & 1 5/8" TUBE</p> <p>Holds up to 10 lbs, 23 Balls</p> <ul style="list-style-type: none"> Suitable for Zebras <p><u>Available Colors: (XX)</u> , (SW) Snow White DISCONTINUED: BLACK (BK)</p> <p>US Patent No. D6300086S China Patent CN201248601Y & CN 201248601Y Taiwan Patent No. M440739</p>	<p>50 PCS / BAG</p> <p>100 PCS / BOX</p>
 <p>5</p>	<p>R-CL12-EZ-XX</p>	<p>EZ ROLL CLUTCH FOR 1-1/2" & 1-5/8" TUBE</p> <p>Holds up to 12 lbs, 32 Balls</p> <p><u>Available Colors: (XX)</u> (BK) Black, (SW) Snow White</p> <p>US Patent No. D6300086S China Patent CN201248601Y & CN 201248601Y Taiwan Patent No. M440739</p>	<p>25 PCS / BAG</p> <p>100 PCS / BOX</p>



ROLLER/ ZEBRA™ SHADE COMPONENTS

All prices are subject to change without notice

FEB 16, 2024

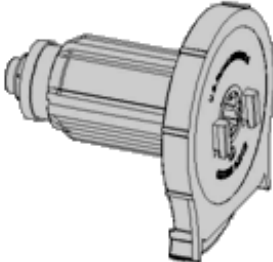
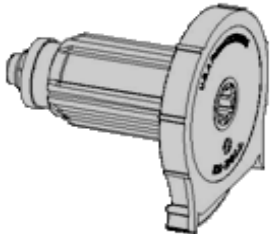
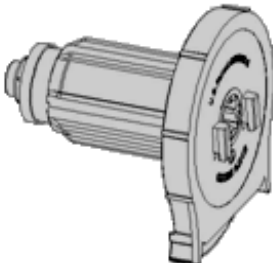
 <p>5 DISCONTINUED</p>	<p>R-CL12-GL-XX</p>	<p>GL CLUTCH FOR 1-1/2" & 1-5/8" TUBE</p> <p>Holds up to 12 lbs, 32 Balls</p> <ul style="list-style-type: none"> Suitable for Zebras <p><u>Available Colors: (XX)</u> (BK) Black, (SW) Snow White</p> <p>US Patent No. D6300086S China Patent CN201248601Y & CN 201248601Y Taiwan Patent No. M440739</p>	<p>25 PCS / BAG</p> <p>100 PCS / BOX</p>
 <p>5</p>	<p>R-CL16-EZ-XX</p>	<p>EZ ROLL CLUTCH FOR 2" TUBE</p> <p>Holds up to 16 lbs, 32 Balls</p> <p>Used on 2" Tube with R-TA-U-XX adaptor</p> <p><u>Available Colors: (XX)</u> (BK) Black, (SW) Snow White</p> <p>US Patent No. D6300086S China Patent CN201248601Y & CN 201248601Y Taiwan Patent No. M440739</p>	<p>25 PCS / BAG</p> <p>100 PCS / BOX</p>
 <p>5 DISCONTINUED</p>	<p>R-CL16-GL-XX</p>	<p>GL CLUTCH FOR 2" TUBE</p> <p>Holds up to 16 lbs, 32 Balls</p> <p>Used on 2" Tube with R-TA-U-XX adaptor</p> <p><u>Available Colors: (XX)</u> (BK) Black, (SW) Snow White</p> <p>US Patent No. D6300086S China Patent CN201248601Y & CN 201248601Y Taiwan Patent No. M440739</p>	<p>25 PCS / BAG</p> <p>100 PCS / BOX</p>



ROLLER/ ZEBRA™ SHADE COMPONENTS

All prices are subject to change without notice

FEB 16, 2024

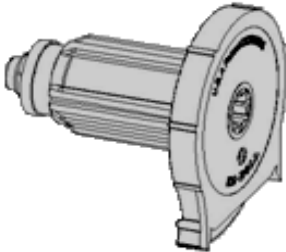
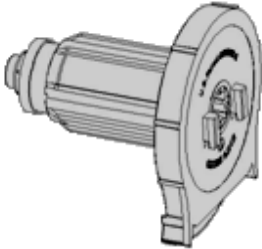
 <p>5</p>	<p>R-CL24-EZ-XX</p>	<p>EZ ROLL CLUTCH FOR 2-1/4" & 2-1/2" TUBE</p> <p>Holds up to 24 lbs, 32 Balls</p> <p>Used on: 2 ¼" Tube with R-TA-U-XX adaptor 2 ½" Tube with R-TA-U-2.5 adaptor</p> <p><u>Available Colors: (XX)</u> (BK) Black, (SW) Snow White</p> <p>US Patent No. D6300086S China Patent CN201248601Y & CN 201248601Y Taiwan Patent No. M440739</p>	<p>25 PCS / BAG</p> <p>100 PCS / BOX</p>
 <p>5 DISCONTINUED</p>	<p>R-CL24-GL-XX</p>	<p>GL CLUTCH FOR 2 1/4" & 2 1/2" TUBE</p> <p>Holds up to 24 lbs, 32 Ball</p> <p>Used on: 2 ¼" Tube with R-TA-U-XX adaptor 2 ½" Tube with R-TA-U-2.5 adaptor</p> <p><u>Available Colors: (XX)</u> (BK) Black, (SW) Snow White</p> <p>US Patent No. D6300086S China Patent CN201248601Y & CN 201248601Y Taiwan Patent No. M440739</p>	<p>25 PCS / BAG</p> <p>100 PCS / BOX</p>

END PLUGS 6

 <p>6</p>	<p>R-EP-MEZ-XX</p>	<p>MINI EZ END PLUG FOR 3/4" MINI TUBE</p> <p>Used with Mini EZ, Mini EZ-Matic & with UNI-Rail-Zebra as optional back fabric adjuster</p> <p><u>Available Colors: (XX)</u> (BK) Black, (SW) Snow White</p>	<p>25 PCS / BAG</p> <p>1,250 PCS / BOX</p>
---	---------------------------	---	--



ROLLER/ ZEBRA™ SHADE COMPONENTS

All prices are subject to change without notice

FEB 16, 2024



 <p>6</p>	<p>R-EP-CL5-U-XX</p>	<p>UNIVERSAL END PLUG FOR 1 1/8" TUBE</p> <p>Use on R-T5-U-1.125 (1 1/8" Tube)</p> <p><u>Available Colors: (XX)</u> (BK) Black, (SW) Snow White</p> <p>*US Patent No. D698624S* *Taiwan Patent No. M418963* *China Patent No.CN 202146190U*</p>	<p>50 PCS / BAG</p> <p>100 PCS / BOX</p>
 <p>6</p>	<p>R-EP-CL8-U-XX</p>	<p>UNIVERSAL END PLUG FOR 1 1/4" TUBE</p> <p><u>Available Colors: (XX)</u> (BK) Black, (SW) Snow White</p> <p>*US Patent No. D698624S* *Taiwan Patent No. M418963* *China Patent No.CN 202146190U*</p>	<p>50 PCS / BAG</p> <p>100 PCS / BOX</p>
 <p>6</p>	<p>R-EPLG-U-XX</p>	<p>UNIVERSAL END PLUG FOR 1 1/2" & 1 5/8" TUBES. Also can be used on GENESIS 2" TUBE</p> <p>Use with all CL12, CL16 & CL 24 EZ clutches (CL16 & CL24 clutches require the R-TA-U-XX adaptors)</p> <p>Use with EZ-Matic without Positioneer</p> <p><u>Available Colors: (XX)</u> (BK) Black, (SW) Snow White</p> <p>*US Patent No. D698624S* *Taiwan Patent No. M418963* *China Patent No.CN 202146190U*</p>	<p>50 PCS / BAG</p> <p>100 PCS/ BOX</p>



ROLLER/ ZEBRA™ SHADE COMPONENTS

All prices are subject to change without notice

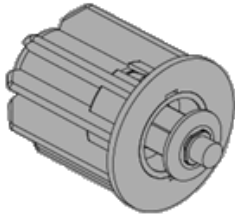
FEB 16, 2024

 <p>6</p>	<p>GEN-EP1.625-XX</p>	<p>GENESIS 1-5/8" TUBE END PLUG also fits Regular 1-5/8" TUBE with 2- groove R-T12-2G-1.625</p> <p><u>Available Colors: (XX)</u> (BK) Black, (SW) Snow White</p> <p>*US Patent No. D698624S* *Taiwan Patent No. M418963* *China Patent No.CN 202146190U*</p>	<p>50 PCS/ BAG 500 PCS/ BOX</p>
	<p>GEN-EP-CL8-U-XX</p>	<p>GENESIS 1-1/4" TUBE END PLUG</p> <p><u>Available Colors: (XX)</u> (BK) Black, (SW) Snow White</p>	<p>50 PCS / BAG 100 PCS / BOX</p>

EZ-MATIC (CORDLESS LIFT) 7

MINI EZ-MATIC LIFT

 <p>7</p>	<p>R-MEZM-3T</p>	<p>MINI EZ-MATIC TENSIONER (Cordless) FOR THE 3/4" MINI TUBE - Always On Left 13" long</p> <ul style="list-style-type: none"> • MAX SHADE SIZE - 9 SQFT • MAX WEIGHT HOLDS UP TO 3 LBS 	<p>1 PC / BAG 25 PCS /BAG</p>
---	-------------------------	---	--



Main Office: 620 S. Jefferson St. Unit A, Placentia, CA 92870 Tel (800) 441-2024 Fax (800) 787-5369
 4570 Shelby Air Dr. Suite 6, Memphis, TN 38118 Tel (901) 360-0058 Fax (901) 365-3007



ROLLER/ ZEBRA™ SHADE COMPONENTS

All prices are subject to change without notice

FEB 16, 2024

<p>*NEW 2018*</p>  <p>7</p>	<p>R-MEZM-4T</p>	<p>MINI EZ-MATIC TENSIONEER (Cordless) FOR THE 3/4" MINI TUBE - Always On Left 17" long</p> <ul style="list-style-type: none"> • MAX SHADE SIZE - 18 SQFT • MAX WEIGHT - UP TO 4 LBS 	<p>1 PC /BAG 25 PCS /BAG</p>
 <p>7</p>	<p>R-MEZM-3P</p>	<p>MINI EZ-MATIC POSITIONEER FOR THE THE 3/4" MINI TUBE, 4-3/4" long</p> <ul style="list-style-type: none"> • MAX WEIGHT - UP TO 3 LBS. 	<p>1 PC/BAG 100 PCS/BIG BAG 500 PCS/BOX</p>

STANDARD EZ-MATIC (CORDLESS) LIFT



<p>*NEW 2020*</p>  <p>7</p>	<p>SPECIAL SIZE</p> <p>R-EZM-FT-2</p>	<p>EZ-MATIC FLUSH TENSIONEER FOR THE 1- 5/8" TUBE (always on left) 12.75" Long</p> <ul style="list-style-type: none"> • MIN SHADE WIDTH: • Positioneer 18", End Plug 16" • MAX SHADES WIDTH 36" • MAX SHADE HEIGHT- 48" • MAX SHADE SIZE - 12 SQFT MAX WEIGHT- UP TO 2 LBS 	<p>1 PC / BAG 50 PCS/Box</p>
--	--	--	----------------------------------



ROLLER/ ZEBRA™ SHADE COMPONENTS

All prices are subject to change without notice

FEB 16, 2024

<p>*NEW 2020*</p>  <p>7</p>	<p>SPECIAL SIZE</p> <p>R-EZM-FT-3A</p>	<p>EZ-MATIC FLUSH TENSIONER FOR THE 1- 5/8" TUBE (always on left) 15.5" Long</p> <ul style="list-style-type: none"> • MIN SHADE WIDTH: • Positioner 22", End Plug 19" • MAX SHADES WIDTH 36" • MAX SHADE HEIGHT- 60" <ul style="list-style-type: none"> • MAX SHADE SIZE - 15 SQFT • MAX WEIGHT- UP TO 3 LBS 	<p>1 PC / BAG</p> <p>50 PCS/Box</p>
<p>*NEW 2018</p>  <p>7</p>	<p>R-EZM-FT-3</p>	<p>EZ-MATIC FLUSH TENSIONER FOR THE 1- 5/8" TUBE (always on left) 16.5" Long</p> <ul style="list-style-type: none"> • MIN SHADE WIDTH: • Positioner 23", End Plug 20" • MAX SHADES WIDTH 36" • MAX SHADE HEIGHT- 60" <ul style="list-style-type: none"> • MAX SHADE SIZE - 15 SQFT • MAX WEIGHT- UP TO 3 LBS 	<p>1 PC / BAG</p> <p>50 PCS/Box</p>



ROLLER/ ZEBRA™ SHADE COMPONENTS

All prices are subject to change without notice

FEB 16, 2024



<p>*NEW 2018</p>  <p>7</p>	<p>R-EZM-FT-5</p>	<p>EZ-MATIC FLUSH TENSIONEER FOR THE 1- 5/8" TUBE (always on left) 24" Long</p> <ul style="list-style-type: none"> • MIN SHADE WIDTH: • Positioneer 30", End Plug 27" • MAX SHADES WIDTH 48" • MAX SHADE HEIGHT- 72" • MAX SHADE SIZE - 24 SQFT • MAX WEIGHT - UP TO 5 LBS 	<p>1 PC / BAG</p> <p>50 PCS/Box</p>
<p>*NEW 2020*</p>  <p>7</p>	<p>R-EZM-FT-8</p>	<p>EZ-MATIC FLUSH TENSIONEER FOR THE 1- 5/8" TUBE (always on left) 26-7/8" Long.</p> <ul style="list-style-type: none"> • MIN SHADE WIDTH: • Positioneer 33", End Plug 30" • MAX SHADE WIDTH - 72" • MAX SHADE HEIGHT- 84" • MAX SHADE SIZE - 42 SQFT • WEIGHT LIMIT - 5 LBS TO 8 LBS 	<p>1 PC / BAG</p> <p>50 PCS/Box</p>
<p>*NEW 2020*</p>  <p>7</p>	<p>R-EZM-FT-10</p>	<p>EZ-MATIC FLUSH TENSIONEER FOR THE 1-5/8" TUBE (Always on left) 35" long. Spring Covered with Black Poly Tube to Minimize Noise</p> <ul style="list-style-type: none"> • MIN SHADE WIDTH: • Positioneer 41", End Plug 38" • MAX SHADE WIDTH - 96" • MAX SHADE HEIGHT- 96" • MAX SHADE SIZE - 64 SQFT • WEIGHT LIMIT - 8 LBS TO 10 LBS 	<p>1 PC / BAG</p> <p>50 PCS/Box</p>



ROLLER/ ZEBRA™ SHADE COMPONENTS

All prices are subject to change without notice

FEB 16, 2024

<p>*NEW 2020*</p>  <p>7</p>	<p>R-EZM-FT-12</p>	<p>EZ-MATIC FLUSH TENSIONER FOR THE 1-5/8" TUBE (Always on left) 42" long. Spring Covered with White Poly Tube to Minimize Noise</p> <ul style="list-style-type: none"> • MIN SHADE WIDTH: • Positioner 48", End Plug 45" • MAX SHADE WIDTH - 96" • MAX SHADE HEIGHT- 144" • MAX SHADE SIZE - 96 SQFT • WEIGHT LIMIT - 10 LBS TO 12 LBS 	<p>1 PC / BAG</p> <p>50 PCS/Box</p>
<p>*NEW 2020*</p>  <p>7</p>	<p>R-EZM-FT-16</p>	<p>EZ-MATIC FLUSH TENSIONER FOR THE 1-5/8" TUBE (Always on left) 42" Long. Spring Covered with Black Poly Tube to Minimize Noise</p> <ul style="list-style-type: none"> • MIN SHADE WIDTH: • Positioner 48", End Plug 45" • MAX SHADE WIDTH - 96" • MAX SHADE HEIGHT- 144" • MAX SHADE SIZE - 96 SQFT • WEIGHT LIMIT - 12 LBS TO 16LBS 	<p>1 PC / BAG</p> <p>50 PCS/Box</p>





ROLLER/ ZEBRA™ SHADE COMPONENTS

All prices are subject to change without notice

FEB 16, 2024

 <p>OUT</p> <p>7</p>	<p>R-EZM-FRP-10</p>	<p>*NEW IMPROVED*</p> <p>EZ-MATIC POSITIONEER * <u>FLUSH IN</u> (Heavy Duty) FOR 1-5/8" TUBE, 4 1/2" Long (use with square hole brackets)</p> <ul style="list-style-type: none"> • Reduces light gap • Zinc plated threaded steel shaft • MAX WEIGHT - UP TO 10 LBS. <p><small>*US Patent No. D698624S*</small> <small>*Taiwan Patent No. M418963*</small> <small>*China Patent No.CN 202146190U*</small></p>	<p>10 PCS / BAG</p>
---	---------------------	--	---------------------

ADDITIONAL CORDLESS PARTS



 <p>7</p>	<p>R-EZM-TH-TC-4.2mm</p>	<p>MINI -MATIC TENSIONEER CRANK</p> <p>4.2mm head</p> <p>Use to add torque to Tensioneer</p>	<p>1 PC / BAG</p>
 <p>7</p>	<p>R-EZM-TH-TC-9.2mm</p>	<p>EZ-MATIC TENSIONEER CRANK</p> <p>9.2mm head</p> <p>Used to add torque to Tensioneer</p>	<p>1 PC / BAG</p>



ROLLER/ ZEBRA™ SHADE COMPONENTS

All prices are subject to change without notice

FEB 16, 2024

 <p>Screws Included</p> <p>7</p>	<p>R-BRE-HANDLE</p>	<p>PLASTIC CLEAR HANDLE FOR Both the ELLIPTICAL & ROUND BOTTOMRAIL on CORDLESS SHADE</p> <ul style="list-style-type: none"> • Use 5/64 drill bit 	<p>100 PCS / BAG</p>
 <p>7</p>	<p>R-BRP-HANDLE</p>	<p>PLASTIC CLEAR HANDLE FOR BOTTOMRAIL HEM BAR on CORDLESS SHADE</p> <ul style="list-style-type: none"> • * USE WITH 5/16" SCREW R-SW-C-8SDS-Z • Use 7/64" drill bit 	<p>50 PCS / BAG</p>
<p>*NEW 2020*</p>  <p>7</p>	<p>R-EZM-BRPOLE</p>	<p>4FT ALUMINUM POLE WITH 2" HOOK FOR CORDLESS BOTTOMRAIL</p> <ul style="list-style-type: none"> • USE ON HIGH-REACH CORDLESS SHADES • EXTENDABLE TO 7.5 FT 	<p>1 EACH</p>



ROLLER/ ZEBRA™ SHADE COMPONENTS

All prices are subject to change without notice

FEB 16, 2024

EZ-Matic Weight Limit & Rotation Guide							Suggested
Tensioneer	Max Wgt.	Min/Max	Width	Length	Brake	Max Sq Ft	Rotations
FT-8 (8 Lb)	8 Lb	Min	30	84	No	17.50	6
	8 Lb	Max	72	84	No	42	15
	8 Lb	Min	33	84	Yes	19.25	6
	8 Lb	Max	72	84	Yes	42	15
FT-10 (10 Lb)	10 Lb	Min	38	96	No	25.33	10
	10 Lb	Max	96	96	No	64	15
	10 Lb	Min	41	96	Yes	27.33	10
	10 Lb	Max	96	96	Yes	64	15
FT-12 (10 Lb)	12 Lb	Min	45	144	No	45	18
	12 Lb	Max	96	144	No	96	22
	12 Lb	Min	48	144	Yes	48	18
	12 Lb	Max	96	144	Yes	96	22
FT-16 (10 Lb)	16 Lb	Min	45	144	No	45	20
	16 Lb	Max	96	144	No	96	25
	16 Lb	Min	48	144	Yes	48	20
	16 Lb	Max	96	144	Yes	96	25

Genes' Positioneers use a metal shaft to handle the wear & tear of long term weight.

Tensioneer is always on the left so rotate clockwise to add tension.

Tensioneer & Brake (if used) side wheels are conveniently placed at either side to easily fine tune the settings.



ROLLER/ ZEBRA™ SHADE COMPONENTS

All prices are subject to change without notice

FEB 16, 2024

EZ-Matic Weight Limit & Rotation Guide							Suggested
Tensioneer	Max Wgt.	Min/Max	Width	Length	Brake	Max Sq Ft	Rotations
FT-8 (8 Lb)	8 Lb	Min	30	84	No	17.50	6
	8 Lb	Max	72	84	No	42	15
	8 Lb	Min	33	84	Yes	19.25	6
	8 Lb	Max	72	84	Yes	42	15
FT-10 (10 Lb)	10 Lb	Min	38	96	No	25.33	10
	10 Lb	Max	96	96	No	64	15
	10 Lb	Min	41	96	Yes	27.33	10
	10 Lb	Max	96	96	Yes	64	15
FT-12 (10 Lb)	12 Lb	Min	45	144	No	45	18
	12 Lb	Max	96	144	No	96	22
	12 Lb	Min	48	144	Yes	48	18
	12 Lb	Max	96	144	Yes	96	22
FT-16 (10 Lb)	16 Lb	Min	45	144	No	45	20
	16 Lb	Max	96	144	No	96	25
	16 Lb	Min	48	144	Yes	48	20
	16 Lb	Max	96	144	Yes	96	25

Genes' Positioneers use a metal shaft to handle the wear & tear of long term weight.

Tensioneer is always on the left so rotate clockwise to add tension.

Tensioneer & Brake (if used) side wheels are conveniently placed at either side to easily fine tune the settings.



ROLLER/ ZEBRA™ SHADE COMPONENTS

All prices are subject to change without notice

FEB 16, 2024

MOTORIZATION 8

AC ELECTRIC MOTOR

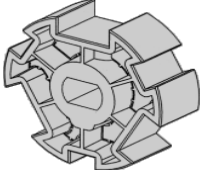
 <p>8</p>	<p>MRS-M-AC10</p> <p>SALE</p>	<p>ELECTRIC MOTOR (AC) - Z CODE Includes special brackets (2 1/8") & Idle Ends Requires Pin on crown to connect to the tube. SS-05 item.</p> <p>54mm to center of hole,19 RPM Length: 19.06" Max Lift: 45 lbs.</p> <p>Fits 2" & 2-1/4" TUBE For 2.5" TUBE, Use crown adaptor, item # MRS-MA-C2.5CC-PART-A.</p>	<p>1 SET/ BAG</p>
 <p>8</p>	<p>MRS-MA-C2.5CC-PART A</p>	<p>CROWN ADAPTOR FOR AC MOTOR 2.5" TUBE</p>	<p>100 PCS/ BAG 500 PCS / BOX</p>





ROLLER/ ZEBRA™ SHADE COMPONENTS

All prices are subject to change without notice

FEB 16, 2024

GENESIS AC ELECTRIC MOTOR & PARTS- Use with GENESIS Tubes

 <p>8</p>	<p>GEN-MOTOR35</p>	<p>GENESIS AC MOTOR (Roller Shade) 120V/60HZ</p> <p>Motor included CROWN, SLEEVE/ADAPTOR, CLIP & BRACKET ADAPTOR (FOR 1-5/8" OR 2" TUBE)</p> <p>Must use end plug GEN-EP1.625-XX for 1-5/8" Genesis Tube or R-TA-2 for 2" Genesis Tube</p> <ul style="list-style-type: none"> • 20 lbs. Lift • 35mm Diameter • 450mm (17.72") Length • 5 Nm Torque • 32 rpm <p>Uses regular 35mm or 45mm EZ Roll 23 Ball brackets</p> <p>Minimum shade width is 21 inches</p>	<p>1SET/BAG</p>
 <p>8</p>	<p>GEN-MOTOR35-ADPT-L</p>	<p>GENESIS AC MOTOR ADAPTOR (Light weight)</p> <p>Motor Bracket Adaptor - screws included 12.5mm slot hole</p> <p>Added to Genesis AC motor for use in motorized light shades/blinds</p>	<p>10C/BAG</p> <p>1,000 / BOX</p>



ROLLER/ ZEBRA™ SHADE COMPONENTS

All prices are subject to change without notice

FEB 16, 2024

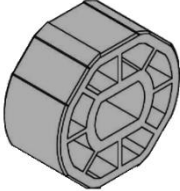
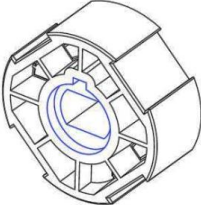
 <p>8</p>	<p>GEN-MOTOR35-ADPT-H</p>	<p>GENESIS AC MOTOR ADAPTOR (Heavy weight) Motor Bracket Adaptor - screws included</p> <p>Added to Genesis AC motor for use in Genesis horizontal or heavy shades/blinds. Creates extra ¼" gap</p>	<p>1 PC/BAG</p>
 <p>8</p>	<p>GEN-MOTOR35-CROWN</p>	<p>GENESIS MOTOR35 ADPT CROWN1.625 (must be ordered with Genesis AC motor using 1-5/8" tube)</p> <p>For GENESIS 16 LB, 2 Groove 1-5/8" Tube</p>	<p>50 / BAG</p> <p>1,000 / BOX</p>
 <p>8</p>	<p>GEN-MOTOR35-CROWN2</p>	<p>GENESIS MOTOR35 ADPT CROWN2 (must be ordered with Genesis AC motor using 2" tube)</p> <p>For GENESIS 20 LB, 2 Groove 2" Tube</p>	<p>50 / BAG</p> <p>500 / BOX</p>



ROLLER/ ZEBRA™ SHADE COMPONENTS

All prices are subject to change without notice

FEB 16, 2024

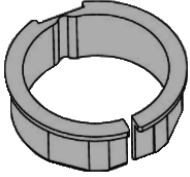
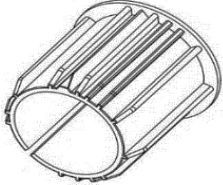
 <p>8</p>	<p>GEN-MOTOR35-CLIP</p>	<p>GENESIS MOTOR35 ADPT CROWN CLIP (must be ordered with AC motor)</p>	<p>1,000 / BAG</p>
 <p>8</p>	<p>GEN-MOTOR35-SLEEVE</p>	<p>GENESIS MOTOR35 ADPT SLEEVE1.625 (sleeve – fits over power wire end of motor for 1.625 atube - must be ordered with AC motor)</p>	<p>50 / BAG 1,000 / BOX</p>
 <p>8</p>	<p>GEN-MOTOR35-SLEEVE2</p>	<p>GENESIS MOTOR35 ADPT SLEEVE2 (sleeve – fits over power wire end of motor for 2" Genesis tube - must be ordered with AC motor)</p>	<p>50 / BAG 1,000 / BOX</p>

DC BATTERY MOTORS

Main Office: 620 S. Jefferson St. Unit A, Placentia, CA 92870
4570 Shelby Air Dr. Suite 6, Memphis, TN 38118

Tel (800) 441-2024
Tel (901) 360-0058

Fax (800) 787-5369
Fax (901) 365-3007



ROLLER/ ZEBRA™ SHADE COMPONENTS

All prices are subject to change without notice

FEB 16, 2024

 <p>8</p>	<p>MRS-M-B-Z</p>	<p>BATTERY MOTOR (DC) - Z CODE Includes EZ Roll motor bracket set (45mm), idler 1- 5/8" tube, and battery wand. Batteries not included.</p> <ul style="list-style-type: none"> • RPM: 34 • Length: 10.83" • Max Lift: 12 LBS <p>Fits Standard 1- 5/8" tube</p>	<p>1 SET/BAG</p>
<p>*NEW 2018*</p>  <p>8</p>	<p>MRS-M25-RB</p>	<p>BUILT-IN RECHARGEABLE BATTERY MOTOR (Charger or Solar panel additional)</p> <ul style="list-style-type: none"> • Battery life per charge: 9 months • Torque: 1.5 Nm, RPM: 30 • Length: 18.75" • Max Lift: 13 LBS <p>Fits <u>standard</u> 1-5/8" tube using End plug R-EPLG-U-XX</p> <p>Uses regular 35mm or 45mm EZ Roll "M" Motor Brackets</p> <p>Minimum shade width is 22 inches</p>	<p>1 SET/BAG</p>

GENESIS DC BATTERY MOTOR



ROLLER/ ZEBRA™ SHADE COMPONENTS

All prices are subject to change without notice

FEB 16, 2024

 <p>8</p>	<p>GEN-M35-RB</p> <p>Sale Price</p>	<p>GENESIS BUILT-IN RECHARGEABLE BATTERY MOTOR (Charger or Solar panel additional)</p> <ul style="list-style-type: none"> • Battery life per charge: 9 months • Torque: 2.5 Nm, RPM: 30 • Length: 22.80" • Max Lift: 20 LBS <p>Comes with GEN-MOTOR35-CROWN, GEN-MOTOR35-SLEEVE & GEN-MOTOR35-CLIP</p> <p>FITS <u>Genesis</u> 1-5/8" and 2" Tube Item# GEN-T16-2G-1.625, and GEN-T20-2</p> <p>USE Genesis end plug, item# GEN-EP1.625-XX when use with Genesis 1-5/8" tube.</p> <p>Uses regular 35mm or 45 mm EZ Roll 23 Ball brackets</p> <p>Minimum width size is 25 inches</p>	<p>1 SET/BAG</p>
--	---	--	-------------------------



MOTORIZATION SUPPLEMENTS



ROLLER/ ZEBRA™ SHADE COMPONENTS

All prices are subject to change without notice

FEB 16, 2024



 8	MRS-MB-CLIP	BATTERY WAND REPLACEMENT CLIPS (3 plastic clips per bag) Used to secure battery wand's position	1 BAG
 8	MRS-MB-T12	TRANSFORMER FOR Battery DC MOTOR MRS-M-B-Z Plugs into wall outlet converts AC to DC	1 PC/BAG
 8	MRS-MB-T12EXT	6' CORD EXTENSION for transformer, Item# MRS-MB-T12	1 PC / BAG



ROLLER/ ZEBRA™ SHADE COMPONENTS

All prices are subject to change without notice

FEB 16, 2024



 <p>8</p>	<p>**NEW 2018**</p> <p>MRS-SOLARP-M25</p>	<p>SOLAR PANEL for Rechargeable Battery Motor (14.4V/2.1W) MRS-M25-RB</p>	<p>1 PC/ BAG</p>
 <p>8</p>	<p>GEN-SOLARP-M35</p>	<p>SOLAR PANEL for Rechargeable Battery Motor, Item# GEN-M35-RB 14.4V/3.5A)</p>	<p>1 PC/BAG</p>
 <p>8</p>	<p>MRS-SPC</p>	<p>SMART PHONE CONTROLLER</p> <p>Interface for Smart Phones 2 3/8 x 3 x 7/8</p> <p>Connects blinds to internet & app via WiFi</p>	<p>1 PC /BAG</p>



ROLLER/ ZEBRA™ SHADE COMPONENTS

All prices are subject to change without notice

FEB 16, 2024

 8	MRS-RBC	RECHARGEABLE BATTERY CHARGER (12.3V/1A) For MRS-M25-RB & GEN-M35-RB	1 PC/BAG
 6 Channel 15 Channel 8	MRS-R2-6SW MRS-R2-6BK MRS-R2-15SW MRS-R2-15BK	RADIO REMOTE CONTROLS - Z CODE Includes battery 6 - Channel (Snow White or Black) 15 - Channel (Snow White or Black)	1 PC/BAG
 8	MRS-R2WM-5SW	WALL-MOUNT REMOTE TRANSMITTER, BATTERY OPERATES, 5-CHANNEL- Z CODE SNOW WHITE ONLY	1 PC/ BAG

SCREWS 9



ROLLER/ ZEBRA™ SHADE COMPONENTS

All prices are subject to change without notice

FEB 16, 2024





 9	WC-S01	SCREW FOR WAND APPLICATION ON MAGNETIC SHAFT SUPPORT (SS-02M) <u>Vertical</u> 3mm (1/8") Flat Phillip Head	250 PCS / BAG
 9	SS-05	SET SCREW 6-32X3/8" SOCKET SET SCREW W/ CUP POINT	100 PCS/BAG
 9	R-SW-F5STS-XX	SCREW FOR 3" & 4" FASCIA & FASCIA CAPS INTO BRACKET <u>Roller Shade</u> 3.1mm x 5mm (13/64") Phillips Flat Head <ul style="list-style-type: none"> SELF TAPPING SCREW <u>Available Colors: (XX)</u> (BK) Black, (BN) Bronze, (SW) Snow White, (SI) Silver	200 PCS / BAG
 9	R-SW-SLCS-6STS	SCREW FOR FASCIA SAFETY LOCK CLIP, BLACK <u>Roller Shade</u> 3.1diameter x 6mm (15/64") Pan Phillip Head <ul style="list-style-type: none"> SELF TAPPING SCREW 	200 PCS / BAG



ROLLER/ ZEBRA™ SHADE COMPONENTS

All prices are subject to change without notice

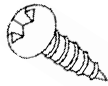
FEB 16, 2024

 9	R-SW-C-6.4SDS	SCREW & NUT FOR 3.5" CASSETTE & UNI-CASSETTE # 2 and # 4 <u>Roller Shade</u> #8/32 X 6.4mm (1/4") Phil machine screw, pan head <ul style="list-style-type: none"> • SELF TAPPING SCREW • PRE-DRILL WITH 9/64" BIT 	500 PCS / BAG
 9	WC-S03	SCREW FOR WAND APPLICATION <u>Vertical</u> #4, 6.4mm (1/4")	1000 PCS/ BAG
 9	R-SW-C-8SDS-Z	SCREW FOR TUBE ADAPTOR <u>Roller Shade</u> 3.5 dia x 8mm (8/32" x 5/16") Phillips Pan Head <ul style="list-style-type: none"> • SELF DRILLING SCREW Used on adaptor with 2 1/4" & 2 1/2" TUBE	500 PCS /BAG
 9	WC-S05	SCREW FOR ATTACHING VC-EZ METAL HANGER TO VALANCE <u>Horizontal</u> #6, 8mm (5/16") Phillips round head	1000 PCS /BAG
 9	R-SW-HH.315+N	HEX SLOT HEAD BOLT & NUT FOR ATTACHING INSTALLATION BRACKETS TO R-GRA (BAR) 8mm (5/16") Hex Head, use drill 9/64" bit	500 PCS /BAG



ROLLER/ ZEBRA™ SHADE COMPONENTS

All prices are subject to change without notice

FEB 16, 2024

 9	R-SW-C-.315SDS+N	PHILLIPS PAN SCREW & NUT FOR ALL CASSETTES, RAILS & BAR <u>Roller Shade</u> #8/32 X 8mm (5/16") Phil machine screw, pan head	500 PCS /BAG
 9	WC-S06	<u>Vertical</u> #6, 9.5mm (3/8") Round Phillip Head <ul style="list-style-type: none"> • SELF TAPPING SCREW 	1,000 / BAG
 9	SN-01	SCREW & NUT FOR INSTALLING EXTENSION BRACKETS <u>Vertical</u> 8/32" X 9.5mm (3/8")	1000 SETS / BAG
 9	R-SW-SN-02 DISCONTINUED	SCREW & NUT FOR 3" VALANCE ENDCAP <u>Roller Shade</u> #8/32 X 9.5mm (3/8") Phil machine screw, pan head <ul style="list-style-type: none"> • SELF TAPPING SCREW 	1000 SETS/BAG
 9	S-13	SCREW TO ATTACH UNIFACE CLIP TO 3" & 4" VALANCE <u>Roller Shade</u> 9.5mm (3/8") Slotted Hex Head	500 PCS / BAG



ROLLER/ ZEBRA™ SHADE COMPONENTS

All prices are subject to change without notice

FEB 16, 2024



 9	R-SW-SA-S-10	SCREW TO LOCK SPRING ASSIST TO CLUTCH CROWN ADAPTOR #6 - 9.5mm (3/8") Phillip Flat Head, Zinc	50 PCS/ BAG
 9	WC-S02	SCREW FOR VERTICAL WAND CONTROL SET <u>Vertical</u> #3, 11mm (7/16")	250 PCS / BAG
 9	R-SW-BR-S12A	SCREW FOR ROUND & ELLIPTICAL BOTTOMRAIL CAPS, ITEM# R-EC-BRR-XX & R-EC-BRE-XX <u>Roller Shade</u> Nickel plated 2.6mm x 12mm (1/2") Flat Phillip head	500 PCS / BAG
 9	S-11	SCREW FOR INSTALLATION OF ALUMINUM MATERIAL <u>Vertical</u> #6, 12mm (1/2"), 1/4" Hex Head, <ul style="list-style-type: none"> • SELF DRILLING SCREW 	500 PCS / BAG
 9	S-12	SCREW TO ATTACH UNIFACE CLIP TO 5.5" VALANCE <u>Roller Shade</u> 12mm (1/2") Hex Slot Head	500 PCS / BAG



ROLLER/ ZEBRA™ SHADE COMPONENTS

All prices are subject to change without notice

FEB 16, 2024

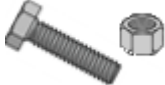
 9	R-SW-LATH.5	SCREW FOR ZEBRA INSTALLATION BRACKETS TO UNI-RAIL™ <u>Roller Shade</u> 12mm (1/2") K-LATH, Phillip Head <ul style="list-style-type: none"> • SELF DRILLING SCREW 	500 / BAG
 9	R-SW-MM-8SDS	SCREW FOR MINI MOUNT BRACKETS <u>Roller Shade</u> #8, 19mm (3/4") Phillips Flat <ul style="list-style-type: none"> • SELF TAPPING SCREW Use with any Mini mount Brackets (Item# R-IB-M23, R-IB-M23L & R-IB-M32)	500 PCS/ BAG
 9	R-SW-HH.75+N	SCREW WITH BOLT & NUT FOR EZ-MATIC™ INSTALLATION BRACKETS TO UNI-RAIL™ 19mm (3/4") Hex Head, drill bit 5/32" Use Flat washer, Item# R-SW-UR-#10W For UNI-RAIL™	200 PCS / BAG
 9	R-SW-UR-#10W	#10 FLAT WASHER Used with R-SW-HH.75+N Zinc Plated ID: 5.45mm Thickness: 1.5mm	200 PCS / BAG



ROLLER/ ZEBRA™ SHADE COMPONENTS

All prices are subject to change without notice

FEB 16, 2024

 <p>9</p>	<p>R-SW-SA-S-11</p>	<p>SCREW FOR GENESIS SPRING ASSIST LOCKING 23 BALL CLUTCH TO CLUTCH ADAPTOR</p> <p>#8 25mm (1") Phillips Pan SMS Head, ZINC Plated</p>	<p>100 PCS/BAG</p>
 <p>9</p>	<p>R-SW-SR2</p> <p>DISCONTINUED</p>	<p>SCREW FOR SLIM SWIVEL HEAD SAFETY LOCK</p> <p>#6 31mm (1-1/4") Phillips Pan Head</p> <p><u>Roller Shade</u> Use on both the Chain R-SSL-CH-U-XX & Cord R-SSL-CD-U-XX Lock.</p>	<p>100 PCS / BAG</p>
 <p>9</p>	<p>S-05</p>	<p>SCREW TO MOUNT BOTH UNI RAIL A & B CLIPS WITHOUT HITTING THE UNI RAIL</p> <p>#6 2.8mm Slot Hex head, 38mm (1-1/2")</p>	<p>100 PCS/BAG</p>
 <p>9</p>	<p>S-08</p> <p><u>BY BAG</u></p> <p><u>BY BOX</u></p>	<p>SCREW FOR BASIC INSTALLATION</p> <p>#8- 38mm (1-1/2") Hex-Washer with Phillips Coarse raised head</p>	<p>1000 PCS / BAG</p> <p>6000 PCS / BOX</p>



ROLLER/ ZEBRA™ SHADE COMPONENTS

All prices are subject to change without notice

FEB 16, 2024

 <p>9</p>	<p>R-SW-SA-S-09</p>	<p>SCREW FOR GENESIS SPRING ASSIST LOCKING 32BALL CLUTCH TO CLUTCH ADAPTOR</p> <p>#8 38mm (1-1/2") Phillips Pan SMS Head, ZINC Plated</p>	<p>100 PCS/BAG</p>
 <p>9</p>	<p>R-SW-MM-8CDWS</p>	<p>SCREW FOR MINI MOUNT DRYWALL/WOOD</p> <p>#8- 41mm (1-5/8") Phillips Flat Coarse, Black</p> <p><u>Roller Shade</u> Use on any Mini Mount Brackets, item # R-IB-M23, R-IB-M23L & R-IB-M32</p>	<p>100 PC/ BAG</p>
 <p>9</p>	<p>R-SW-SRE2</p>	<p>SCREW FOR SLIM SAFETY LOCK EXTENDER Item# R-SLE-U-XX</p> <p>#6 - 44mm (1-3/4") Phillips Pan Head</p>	<p>100 PCS / BAG</p>
	<p>RI-02</p>	<p>1/8 ALUM POP RIVET-LARGE FLANGE</p>	<p>500 PCS/ Bag</p>



ROLLER/ ZEBRA™ SHADE COMPONENTS

All prices are subject to change without notice

FEB 16, 2024

SHADE COVERS 10

SHADE COVERS, CAPS, CLIPS & FABRIC INSERTS

<p>* DISCONTINUED*</p> <p>10</p> 	<p>R-SC-V3-U-XX</p>	<p>UNIVERSAL 3" VALANCE (16 FT) (ALUMINUM)</p> <p>Height: 3" Width: 2 3/4"</p> <p>Used with R-MC-V3-Z</p> <p><u>Available Colors: (XX)</u> (BK) Black, (BN) Bronze,</p>	<p>10 PCS/ BUNDLE (160 FT)</p>
<p>** DISCONTINUED**</p>  <p>10</p>	<p>R-EC-V3-XX</p>	<p>3" VALANCE END CAP COVER</p> <p>Height: 3 1/2" Width: 3 1/2" (can be reduced to 2 3/4")</p> <p><u>Available Colors: (XX)</u> (BK) Black, (BN) Bronze, (SI) Silver</p> <p>*US Patent No. 7857034B2* *Taiwan Patent No. M351674*</p>	<p>100 PCS / BAG 400 PCS / BOX</p>



ROLLER/ ZEBRA™ SHADE COMPONENTS

All prices are subject to change without notice

FEB 16, 2024

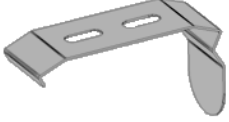
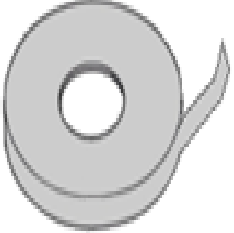
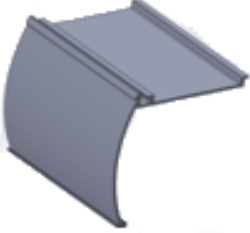
<p>** DISCONTINUED**</p> <p>10</p> 	<p>R-MC-V3-Z</p>	<p>3" VALANCE MOUNTING CLIP</p> <p>Used on R-SC-V3-EZ</p> <p>Zinc Plated Spring Steel</p>	<p>100 PCS / BAG</p>
<p>** DISCONTINUED**</p>  <p>10</p>	<p>R-SC-CF72</p>	<p>72mm CLEAR BACKING FILM</p> <p>For 3" Valance with Fabric Insert</p>	<p>100 FT / ROLL</p>
<p>10</p> 	<p>R-SC-V4-U-XX</p>	<p>UNIVERSAL 4" VALANCE (16 FT) (ALUMINUM)</p> <p>Height: 4 1/8" Width: 3 7/8" Used with R-MC-V4-Z <u>Available Colors: (XX)</u> (SW) Snow White <u>Available Discontinued Colors: (XX)</u> (BK) Black, (BN) Bronze (SI) Silver</p>	<p>5 PCS / BUNDLE (80 FT)</p>



ROLLER/ ZEBRA™ SHADE COMPONENTS

All prices are subject to change without notice

FEB 16, 2024

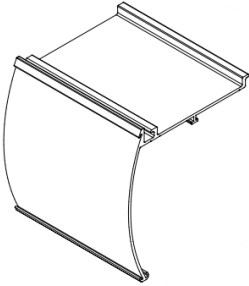
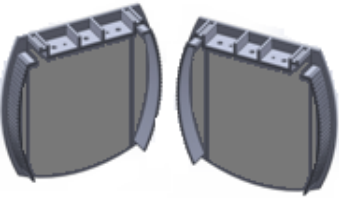
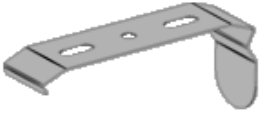
 <p>10</p>	<p>R-SC-V4-U-XX</p>	<p>UNIVERSAL 4" VALANCE (16 FT) (ALUMINUM) T Rail in the middle Height: 4 1/8" Width: 3 7/8" Used with R-MC-V4-Z <u>Available Colors: (XX)</u> (SW) Snow White</p>	<p>5 PCS / BUNDLE (80 FT)</p>
 <p>10</p>	<p>R-EC-V4-XX</p>	<p>4" VALANCE END CAP COVER Height: 4 5/8" Width: 4 3/4" <u>Available Colors: (XX)</u> (SW) Snow White <u>Available Discontinued Colors: (XX)</u> (BK) Black, (BN) Bronze, (SI) Silver *US Patent No. 7857034B2* *Taiwan Patent No. M351674*</p>	<p>50 PCS / BAG 200 PCS / BOX</p>
 <p>10</p>	<p>R-MC-V4-Z</p>	<p>4" VALANCE MOUNTING CLIP Used on R-SC-V4-EZ Zinc Plated Spring Steel</p>	<p>100 PCS / BAG</p>



ROLLER/ ZEBRA™ SHADE COMPONENTS

All prices are subject to change without notice

FEB 16, 2024



 <p>10</p>	<p>R-SC-CF104</p>	<p>104mm CLEAR BACKING FILM</p> <p>For 4" Valance & 4" Curved UNI-Face with Fabric Insert</p>	<p>100 FT / ROLL</p>
 <p>10</p>	<p>R-SC-C2.5-GL-XX</p> <p>R-SC-C2.5-GL-BK-8</p>	<p>GL 2.5" CASSETTE (16 FT) (ALUMINUM)</p> <p>Front Height: 2 ½" Top to Back Width: 2 ¾"</p> <p>For 23 Ball Clutches Used with R-MC-C2.5-Z</p> <p><u>Available Colors: (XX)</u> (SW) Snow White <u>Available Discontinued Colors: (XX)</u> (BK) Black, (BN) Bronze</p> <p>US Patent No D699,976S China Patent# CN202866616</p>	<p>4 PCS / BUNDLE (64 FT)</p>
 <p>10</p>	<p>R-EC-C2.5-XX</p>	<p>GL 2.5" CASSETTE END CAP COVER</p> <p>Height: 2 ½" Width: 2 ¾" Same as left or right</p> <p><u>Available Colors: (XX)</u> (SW) Snow White, <u>Available Discontinued Colors: (XX)</u> (BK) Black, (BN) Bronze, (IV) Ivory</p> <p>*US Patent No. 7857034B2* *Taiwan Patent No. M351674*</p>	<p>50 PCS / BAG</p> <p>200 PCS / BOX</p>



ROLLER/ ZEBRA™ SHADE COMPONENTS

All prices are subject to change without notice

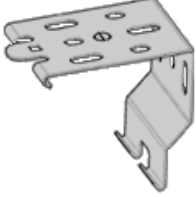
FEB 16, 2024

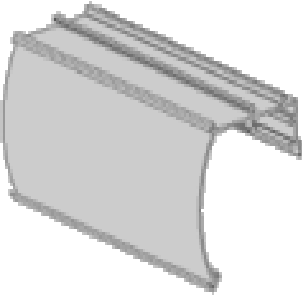

 <p>10</p>	<p>R-MC-C2.5-Z</p>	<p>GL CASSETTE 2 ½" MOUNTING CLIP</p> <p>Used on R-SC-C2.5-GL</p> <p>Zinc Plated Spring Steel</p>	<p>200 PCS / BAG</p>
 <p>10</p>	<p>R-SC-CF68</p>	<p>68mm CLEAR BACKING FILM</p> <p>For 2.5" Cassette Fabric Insert</p>	<p>100 FT / ROLL</p>
 <p>10</p>	<p>R-SC-C3.5-GL-XX</p>	<p>GL 3.5" CASSETTE (16 FT) (ALUMINUM)</p> <p>Front Height: 3.5" Top to Back Width: 3"</p> <p>For 23 Ball or 32 Ball Clutches Used with R-MC-C3.5-Z</p> <p>Available Colors: (XX) (XX) (BK) Black, (BN) Bronze, (IV) Ivory, (SI) Silver (SW) Snow White,</p> <p>US Patent No D699,976S China Patent# CN202866616</p>	<p>4 PCS / BUNDLE (64 FT)</p>



ROLLER/ ZEBRA™ SHADE COMPONENTS

All prices are subject to change without notice

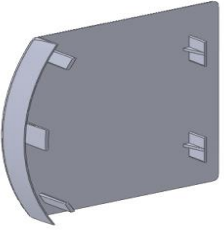
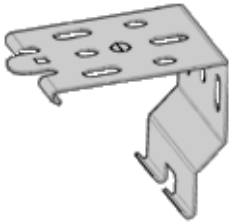
FEB 16, 2024

 <p>10</p>	<p>R-EC-C3.5-XX</p>	<p>3.5" CASSETTE END CAP COVER</p> <p>Height: 3.5" Width: 3 7/8" Same as left or right</p> <p><u>Available Colors: (XX)</u> (BK) Black, (BN) Bronze, (IV) Ivory (SI) Silver, (SW) Snow White,</p> <p>*US Patent No. 7857034B2* *Taiwan Patent No. M351674*</p>	<p>100 PCS / BAG</p> <p>1,000 PCS / BOX</p>
 <p>10</p>	<p>R-MC-C3.5-Z</p>	<p>GL 3.5" CASSETTE MOUNTING CLIP ZINC PLATED SPRING STEEL</p>	<p>100 PCS / BAG</p> <p>500 PCS / BOX</p>
 <p>10</p>	<p>R-SC-CF87</p>	<p>87mm CLEAR BACKING FILM</p> <p>For 3.5" Cassette & 3.5" Curved Uni-Face with Fabric Insert</p>	<p>100 FT / ROLL</p>



ROLLER/ ZEBRA™ SHADE COMPONENTS

All prices are subject to change without notice

FEB 16, 2024

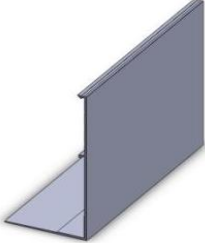
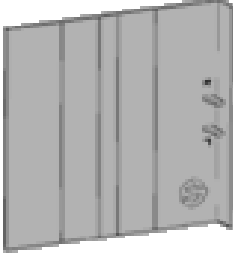
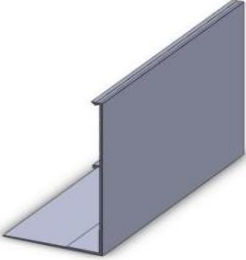
 <p>** DISCONTINUED **</p> <p>10</p>	<p>R-SC-F2.5-U-XX</p>	<p>UNIVERSAL 2 1/2" FLAT PRIVACY FASCIA (16 FT ALUMINUM)</p> <p>Height: 2 3/8" Width: 1 3/8"</p> <p>Available Colors: (XX) (BK) Black, (BN) Bronze, (SW) Snow White, (SI) Silver</p> <p>US Patent No. 7857034B2 US Patent # D737,671S Taiwan Patent #M475240</p>	<p>4 PCS / BUNDLE (64 FT)</p>
 <p>10</p>	<p>Discontinued R-EC-F2.5-XX</p>	<p>2 1/2" FLAT FASCIA END CAP COVER</p> <p>Height 2 1/2" Width: 2 1/2"</p> <p><u>Available Colors: (XX)</u> (BK) Black, (BN) Bronze, (SW) Snow White, (SI) Silver</p> <p>*US Patent No. 7857034B2* *Taiwan Patent No. M351674*</p>	<p>50 PCS / BAG 1,000 PCS / BOX</p>
 <p>10</p>	<p>R-SC-F3-U-XX</p>	<p>3" FLAT PRIVACY FASCIA (16 FT) (ALUMINUM)</p> <p>Height: 3" Width: 1 3/8"</p> <p><u>Available Colors: (XX)</u> (SW) Snow White <u>Available Discontinued Colors: (XX)</u> (IV) Ivory (BK) Black, (SI) Silver</p> <p>US Patent No. 7857034B2 US Patent # D737,671S Taiwan Patent #M475240</p>	<p>4 PCS / BUNDLE (64 FT)</p>



ROLLER/ ZEBRA™ SHADE COMPONENTS

All prices are subject to change without notice

FEB 16, 2024

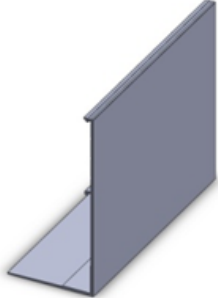
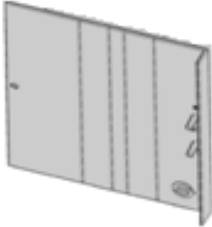
 <p>10</p>	<p>R-EC-F3-XX</p>	<p>3" FLAT FASCIA END CAP COVER Use 5mm screw R-SW-F5STS-XX, not included</p> <p>Height: 3 1/4" Width: 3 1/2"</p> <p><u>Available Colors: (XX)</u> (SW) Snow White, <u>Available Discontinued Colors: (XX)</u> (BK) Black, (BN) Bronze (IV) Ivory, (SI) Silver *US Patent No. 7857034B2* *Taiwan Patent No. M351674*</p>	<p>50 PCS / BAG 1,000 PCS / BOX</p>
 <p>10</p>	<p>R-SC-F4-U-XX</p>	<p>4" FLAT PRIVACY FASCIA (16 FT) (ALUMINUM)</p> <p>Height: 3-3/4" Width: 1 3/4"</p> <p><u>Available Colors: (XX)</u> (BK) Black, (SW) Snow White, (SI) Silver</p> <p>US Patent No. 7857034B2 US Patent # D737,671S Taiwan Patent #M475240</p>	<p>4 PCS / BUNDLE (64 FT)</p>
 <p>10</p>	<p>R-EC-F4-XX</p>	<p>4" FLAT FASCIA END CAP COVER Use screw R-SW-F5STS-XX, not included</p> <p>Height: 3 7/8" Width: 3 7/16"</p> <p><u>Available Colors: (XX)</u> (BK) Black, (SW) Snow White, (SI) Silver <u>Available Discontinued Colors: (XX)</u> (BN) Bronze, (IV) Ivory</p> <p>*US Patent No. 7857034B2* *Taiwan Patent No. M351674*</p>	<p>100 PCS / BAG 1,000 PCS / BOX</p>

Main Office: 620 S. Jefferson St. Unit A, Placentia, CA 92870 Tel (800) 441-2024 Fax (800) 787-5369
4570 Shelby Air Dr. Suite 6, Memphis, TN 38118 Tel (901) 360-0058 Fax (901) 365-3007



ROLLER/ ZEBRA™ SHADE COMPONENTS

All prices are subject to change without notice

FEB 16, 2024

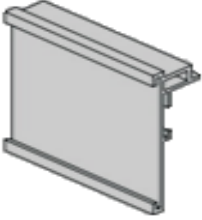
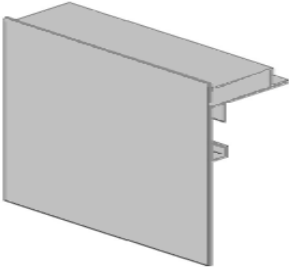
 <p>R-UF-F(X)-XX</p> <p>10</p>	<p>Discontinued R-UF-F3-XX</p>	<p>3" FLAT UNI-FACE™ (16 FT) (ALUMINUM) Optional 3" Decorative Face with Fabric Insert Channel, MUST use Uniface clip R-UFC-S</p> <p><u>Available Colors: (XX)</u> (SW) Snow White, <u>Available Discontinued Colors: (XX)</u> (BK) Black, (BN) Brown, (IV) Ivory,</p> <p>US Patent 9,617,785 B2 Taiwan Patent 495169, M499168, M519934 Chinese Patent CN 204015899U Chinese Patent CN 204212673U Chinese Patent CN 204970765U</p>	<p>8 PCS/ BUNDLE (128 FT)</p>
<p>** 2018 NEW**</p>  <p>10</p>	<p>Discontinued R-UF-F3S-XX</p> <p>Please use R-UF-F3S-XX-NEW</p>	<p>3" FLAT SMOOTH UNI-FACE™ (16 FT) (ALUMINUM) Optional 3" Smooth Flat Decorative Face with NO Fabric Insert Channel</p> <p>Requires R-UFC-S</p> <p><u>Available Colors: (XX)</u> (SW) Snow White, (BK) Black</p> <p><u>Available Discontinued Colors: (XX)</u> (IV) Ivory, (BN) Brown</p> <p>US Patent 9,617,785 B2 Taiwan Patent 495169, M499168, M519934 Chinese Patent CN 204015899U Chinese Patent CN 204212673U Chinese Patent CN 204970765U</p>	<p>8 PCS/ BUNDLE (128 FT)</p>



ROLLER/ ZEBRA™ SHADE COMPONENTS

All prices are subject to change without notice

FEB 16, 2024

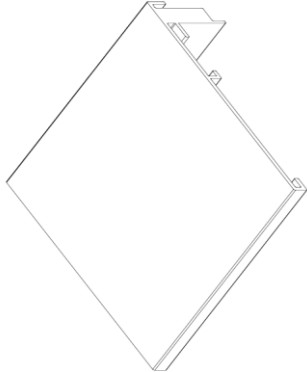
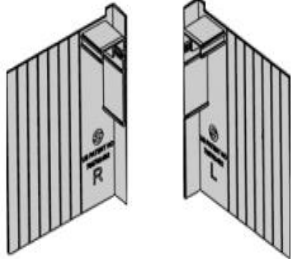

	<p>R-UF-F3S-XX-NEW</p>	<p>3" FLAT SMOOTH UNI-FACE™ (16 FT) (ALUMINUM)</p> <p>Able to do Fabric Wraps. -Please use R-M-T-PI-8T insert R-M-T-DS for the top</p> <p>Optional 3" Smooth Flat Decorative Face with <u>NO</u> Fabric Insert Channel</p> <p>Requires R-UFC-S</p> <p><u>Available Colors: (XX)</u> (SW) Snow White, (BK) Black</p> <p>US Patent 9,617,785 B2 Taiwan Patent 495169, M499168, M519934 Chinese Patent CN 204015899U Chinese Patent CN 204212673U Chinese Patent CN 204970765U</p>	<p>8 PCS/ BUNDLE (128 FT)</p>
 <p>10</p>	<p>R-UF-F3EC-XX</p>	<p>3" FLAT UNI-FACE™ END CAP (L & R)</p> <p>3" returns scored at 5/16 intervals to customize return length</p> <p><u>Available Colors: (XX)</u> (SW) Snow White, (BK) Black <u>Available Discontinued Colors: (XX)</u> (IV) Ivory, (BN) Brown,</p> <p>US Patent 7857034B2 Taiwan Patent 495169 Chinese Patent CN 204015899U</p>	<p>50 SETS / BAG</p> <p>200 SETS / BOX</p>



ROLLER/ ZEBRA™ SHADE COMPONENTS

All prices are subject to change without notice

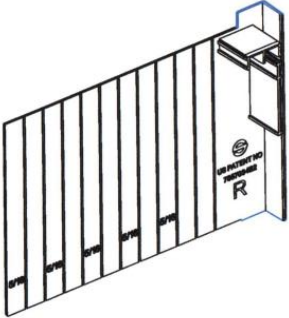
FEB 16, 2024

	<p>R-UF-F3EC-XX-NEW</p>	<p>3" FLAT UNI-FACE™ END CAP (L & R)</p> <p>End caps for R-UF-F3S-XX-NEW 3" returns scored at 5/16 intervals to customize return length</p> <p><u>Available Colors: (XX)</u> (SW) Snow White, (BK) Black</p> <p>US Patent 7857034B2 Taiwan Patent 495169 Chinese Patent CN 204015899U</p>	<p>50 SETS / BAG</p> <p>200 SETS / BOX</p>
	<p>R-SC-CF75</p>	<p>New* 73mm CLEAR BACKING FILM</p> <p>For 3" Flat UNI Face with Fabric Insert</p>	<p>100 FT/ ROLL</p>

10



ROLLER/ ZEBRA™ SHADE COMPONENTS

All prices are subject to change without notice

FEB 16, 2024

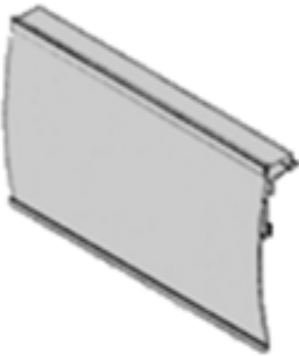
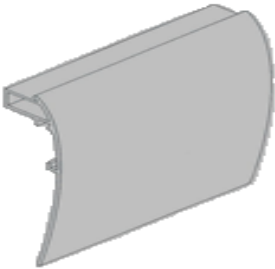
 <p>10</p>	<p>Discontinued R-UF-C3.5-XX</p> <p>Please use R-UF-C3.5S-XX-New</p>	<p>3.5" CURVED UNI-FACE™ (16 FT) (ALUMINUM)</p> <p>Optional Curved 3.5" Decorative Face with Fabric Insert Channel</p> <p>Requires R-UFC-S</p> <p><u>Available Colors: (XX)</u> (SW) Snow White, (BK) Black</p> <p><u>Available Discontinued Colors: (XX)</u> (IV) Ivory, (BN) Brown, F</p> <p>US Patent 9,617,785 B2 Taiwan Patent 495169, M499168, M519934 Chinese Patent CN 204015899U Chinese Patent CN 204212673U Chinese Patent CN 204970765U</p>	<p>4 PCS/ BUNDLE (64 FT)</p>
 <p>** 2018 NEW**</p> <p>10</p>	<p>Discontinued R-UF-C3.5S-XX</p> <p>Please use R-UF-C3.5S-XX-New</p>	<p>3.5" CURVED SMOOTH UNI-FACE™ (16 FT) ALUMINUM</p> <p>Optional Curved 3.5" Decorative Face with NO Fabric Insert Channel (16 Ft)</p> <p>Requires R-UFC-S</p> <p><u>Available Colors: (XX)</u> (SW) Snow White</p> <p><u>Available Discontinued Colors: (XX)</u> (BK) Black, (BN) Brown, (IV) Ivory</p> <p>US Patent 9,617,785 B2 Taiwan Patent 495169, M499168, M519934 Chinese Patent CN 204015899U Chinese Patent CN 204212673U Chinese Patent CN 204970765U</p>	<p>4 PCS/ BUNDLE (64 FT)</p>



ROLLER/ ZEBRA™ SHADE COMPONENTS

All prices are subject to change without notice

FEB 16, 2024

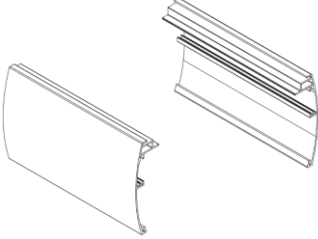
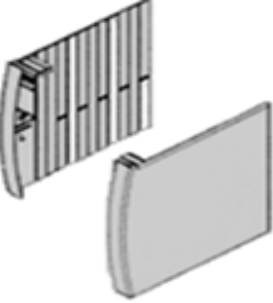
	<p>R-UF-C3.5S-XX-New</p>	<p>3.5" CURVED SMOOTH UNI-FACE™ (16 FT) ALUMINUM Able to do Fabric Wraps. -Please use R-M-T-PI-8T insert R-M-T-DS for the top</p> <p>Optional Curved 3.5" Decorative Face with NO Fabric Insert Channel (16 Ft)</p> <p>Requires R-UFC-S</p> <p><u>Available Colors: (XX)</u> (SW) Snow White (BK) Black</p> <p>US Patent 9,617,785 B2 Taiwan Patent 495169, M499168, M519934 Chinese Patent CN 204015899U Chinese Patent CN 204212673U Chinese Patent CN 204970765U</p>	<p>4 PCS/ BUNDLE (64 FT)</p>
 <p>10</p>	<p>Discontinued R-UF-C3.5EC-XX</p>	<p>3.5" CURVED UNI-FACE™ & 3.5" SMOOTH CURVED UNI-FACE™ END CAP (L & R)</p> <p>3.5" returns scored at 5/16 intervals to customize return length</p> <p><u>Available Colors: (XX)</u> (SW) Snow White, <u>Available Discontinued Colors: (XX)</u> (IV) Ivory, (BN) Brown, (BK) Black</p> <p>US Patent 7857034B2 Taiwan Patent 495169 Chinese Patent CN 204015899U</p>	<p>50 SETS / BAG 200 SETS / BOX</p>



ROLLER/ ZEBRA™ SHADE COMPONENTS

All prices are subject to change without notice

FEB 16, 2024

	<p>R-UF-C3.5EC-XX-NEW</p>	<p>3.5" CURVED UNI-FACE™ & 3.5" SMOOTH CURVED UNI-FACE™ END CAP (L & R)</p> <p>This is for R-UF-C3.5S-XX-New</p> <p>3.5" returns scored at 5/16 intervals to customize return length</p> <p><u>Available Colors: (XX)</u> (SW) Snow White, (BK) Black</p> <p>US Patent 7857034B2 Taiwan Patent 495169 Chinese Patent CN 204015899U</p>	<p>50 SETS / BAG</p> <p>200 SETS / BOX</p>
 <p>10</p>	<p>R-SC-CF87</p>	<p>87mm CLEAR BACKING FILM</p> <p>For 3.5" Cassette & 3.5" Curved Uni-Face with Fabric Insert</p>	<p>100 FT / ROLL</p>



ROLLER/ ZEBRA™ SHADE COMPONENTS

All prices are subject to change without notice

FEB 16, 2024

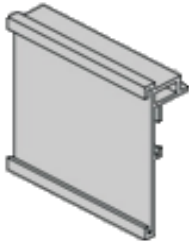
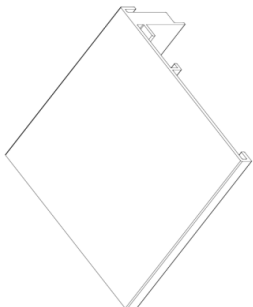

 <p>R-UF-F(X)-XX</p> <p>10</p>	<p>Discontinued R-UF-F4-XX</p>	<p>4" FLAT UNI-FACE™ (16 FT) (ALUMINUM)</p> <p>Optional 4" Decorative Face with Fabric Insert Channel</p> <p>Requires R-UFC-S <u>Available Colors: (XX)</u> (BK) Black, (SW) Snow White, <u>Available Discontinued Colors: (XX)</u> (BN) Brown, (IV) Ivory,</p> <p>US Patent 9,617,785 B2 Taiwan Patent 495169, M499168, M519934 Chinese Patent CN 204015899U Chinese Patent CN 204212673U Chinese Patent CN 204970765U</p>	<p>8 PCS/ BUNDLE (128 FT)</p>
 <p>10</p>	<p>R-UF-F4W-XX-ABBA R-UF-F4W-IV</p>	<p>4" FLAT UNI-FACE™ (16 FT) (ALUMINUM) Able to do Fabric Wraps. -Please use R-M-T-PI-8T insert R-M-T-DS for the top</p> <p>Optional 4" Decorative Face with Fabric Insert Channel</p> <p>Requires R-UFC-S <u>Available Colors: (XX)</u> (BK) Black, (SW) Snow White, (IV) Ivory</p> <p>US Patent 9,617,785 B2 Taiwan Patent 495169, M499168, M519934 Chinese Patent CN 204015899U Chinese Patent CN 204212673U Chinese Patent CN 204970765U</p>	<p>8 PCS/ BUNDLE (128 FT)</p>



ROLLER/ ZEBRA™ SHADE COMPONENTS

All prices are subject to change without notice

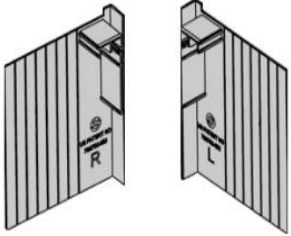
FEB 16, 2024

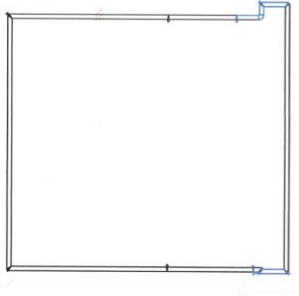
 <p>10</p>	<p>R-UF-F4EC-XX</p>	<p>4" FLAT UNI-FACE & FLAT UNI-FASCIA™ END CAP (L & R)</p> <p>4" returns scored at 5/16 intervals to customize return length</p> <p><u>Available Colors:(XX)</u> (SW) Snow White, (BK) Black,</p> <p><u>Available Discontinued Colors:(XX)</u> (BN) Brown, (IV) Ivory,</p> <p>US Patent 7857034B2 Taiwan Patent 495169 Chinese Patent CN 204015899U</p>	<p>50 SETS / BAG</p> <p>200 SETS / BOX</p>
 <p>10</p>	<p>R-SC-CF100</p>	<p>New* 98mm CLEAR BACKING FILM</p> <p>For 4" FLAT UNI Face with Fabric Insert</p>	<p>100 FT / ROLL</p>
 <p>10</p>	<p>R-UF-F4EC-XX-NEW</p>	<p>4" FLAT UNI-FACE & FLAT UNI-FASCIA™ END CAP (L & R)</p> <p>This is for R-UF-F4W-XX-ABBA</p> <p>4" returns scored at 5/16 intervals to customize return length</p> <p><u>Available Colors:(XX)</u> (SW) Snow White, (BK) Black,</p> <p>US Patent 7857034B2 Taiwan Patent 495169 Chinese Patent CN 204015899U</p>	<p>50 SETS / BAG</p> <p>200 SETS / BOX</p>



ROLLER/ ZEBRA™ SHADE COMPONENTS

All prices are subject to change without notice

FEB 16, 2024

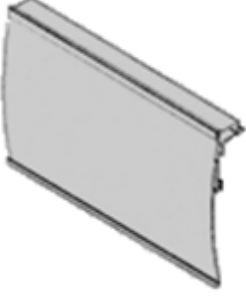
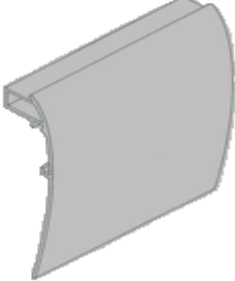
 <p>10</p>	<p>R-UF-C4-XX</p>	<p>4" CURVED UNI-FACE™ (16 FT) (ALUMINUM) Optional Curved 4" Decorative Face with Fabric Insert Channel Requires R-UFC-S</p> <p><u>Available Colors: (XX)</u> (IV) Ivory, (SW) Snow White <u>Available Discontinued Colors: (XX)</u> (BK) Black, (BN) Brown</p> <p>US Patent 9,617,785 B2 Taiwan Patent 495169, M499168, M519934 Chinese Patent CN 204015899U Chinese Patent CN 204212673U Chinese Patent CN 204970765U</p>	<p>4 PCS/ BUNDLE (64 FT)</p>
 <p>** 2018 NEW **</p> <p>10</p>	<p>R-UF-C4S-XX</p>	<p>4" CURVED SMOOTH UNI-FACE™ Optional Curved 4" Decorative Face with <u>NO</u> Fabric Insert Channel Requires R-UFC-S</p> <p><u>Available Colors: (XX)</u> (SW) Snow White, (BK) BLACK <u>Available Discontinued Colors: (XX)</u> (BN) Brown, (IV) Ivory,</p> <p>US Patent 9,617,785 B2 Taiwan Patent 495169, M499168, M519934 Chinese Patent CN 204015899U Chinese Patent CN 204212673U Chinese Patent CN 204970765U</p>	<p>4 PCS/ BUNDLE (64 FT)</p>



ROLLER/ ZEBRA™ SHADE COMPONENTS

All prices are subject to change without notice

FEB 16, 2024

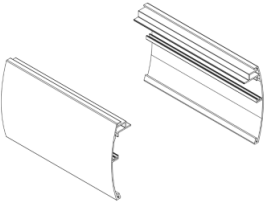
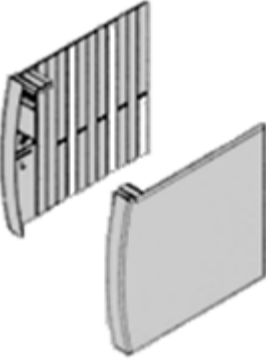

 <p>10</p>	<p>R-UF-C4S-XX-NEW</p>	<p>4" CURVED SMOOTH UNI-FACE™</p> <p>Able to do Fabric Wraps. -Please use R-M-T-PI-8T insert R-M-T-DS for the top</p> <p>Optional Curved 4" Decorative Face with NO Fabric Insert Channel</p> <p>Requires R-UFC-S</p> <p><u>Available Colors: (XX)</u> (SW) Snow White, (BK) Black, (BN) Brown</p> <p>US Patent 9,617,785 B2 Taiwan Patent 495169, M499168, M519934 Chinese Patent CN 204015899U Chinese Patent CN 204212673U Chinese Patent CN 204970765U</p>	<p>4 PCS/ BUNDLE (64 FT)</p>
 <p>10</p>	<p>R-UF-C4EC-XX</p>	<p>4" CURVED UNI-FACE™ & CURVED UNI-FASCIA END CAP (L &R)</p> <p>4" returns scored at 5/16 intervals to customize return length</p> <p><u>Available Colors: (XX)</u> (SW) Snow White, (IV) Ivory</p> <p><u>Available Discontinued Colors: (XX)</u> (BK) Black, (BN) Brown,</p> <p>US Patent 7857034B2 Taiwan Patent 495169 Chinese Patent CN 204015899U</p>	<p>50 SETS / BAG 200 SETS / BOX</p>



ROLLER/ ZEBRA™ SHADE COMPONENTS

All prices are subject to change without notice

FEB 16, 2024

 <p>10</p>	<p>R-UF-C4EC-XX-New</p>	<p>4" CURVED UNI-FACE™ & CURVED UNI-FASCIA END CAP (L &R)</p> <p>This is for R-UF-C4S-XX-NEW</p> <p>4" returns scored at 5/16 intervals to customize return length <u>Available Colors: (XX)</u> (SW) Snow White, (BK) Black</p> <p>US Patent 7857034B2 Taiwan Patent 495169 Chinese Patent CN 204015899U</p>	<p>50 SETS / BAG</p> <p>200 SETS / BOX</p>
 <p>10</p>	<p>R-SC-CF104</p>	<p>104mm CLEAR BACKING FILM</p> <p>For 4" Valance & 4" Curved UNI-Face with Fabric Insert</p>	<p>100 FT / ROLL</p>



ROLLER/ ZEBRA™ SHADE COMPONENTS

All prices are subject to change without notice

FEB 16, 2024

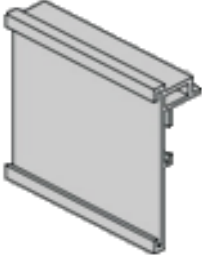
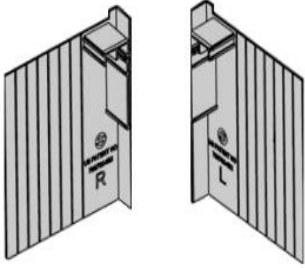
 <p>R-UF-F(X)-XX</p> <p>10</p>	<p>R-UF-F5.5-XX</p>	<p>5.5" FLAT UNI-FACE™ (16 FT) (ALUMINUM)</p> <p>Optional 5.5" Decorative Face with Fabric Insert Channel</p> <p>USE with UNIFACE CLIP (R-UF-C-S)</p> <p><u>Available Colors: (XX)</u> SW) Snow White, (BN) Brown</p> <p>US Patent 9,617,785 B2 Taiwan Patent 495169, M499168, M519934 Chinese Patent CN 204015899U Chinese Patent CN 204212673U Chinese Patent CN 204970765U</p>	<p>5 PCS /BUNDLE (80 FT)</p>
 <p>10</p>	<p>R-UF-F5.5EC-XX</p>	<p>5.5" UNI-FACE™ END CAP (L/R)</p> <p>6" returns scored at 5/16 intervals to customize return length</p> <p><u>Available Colors: (XX)</u> SW) Snow White, Discontinued: BK) Black, (BN) Brown, (IV) Ivory,</p> <p>US Patent 7857034B2 Taiwan Patent 495169 Chinese Patent CN 204015899U</p>	<p>25 SETS/ BAG 100 SETS / BOX</p>



ROLLER/ ZEBRA™ SHADE COMPONENTS

All prices are subject to change without notice

FEB 16, 2024

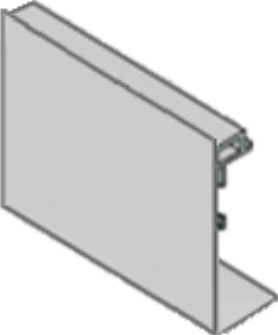
 <p>10</p>	<p>R-SC-CF136.5</p>	<p>136.5mm CLEAR BACKING FILM New rolls will be at 136mm for easier fit</p> <p>For 5.5" Flat UNI-Face with Fabric Insert</p>	<p>100 FT / ROLL</p>
 <p>10</p>	<p>R-UF-F4F-XX-NEW</p>	<p>4" FLAT UNI-FACE™ FASCIA (16 FT) (ALUMINUM) NEW ** 54mm bottom return</p> <p>*Same endcap R-UF-F4EC-XX as 4" FLAT UNI-Face</p> <p>Optional 4" Flat Decorative Face with no Fabric Insert Channel</p> <p>USE with UNIFACE CLIP (R-UFC-S)</p> <p><u>Available Colors:(XX)</u> (SW) Snow White</p> <p><u>Available Discontinued Colors:(XX)</u> (BK) Black, (BN) Brown, (IV) Ivory,</p> <p>US Patent 9,617,785 B2 Taiwan Patent 495169, M499168 & M519934 Chinese Patent CN 2040970765U Chinese Patent CN 204015899U Chinese Patent CN 204212673U</p>	<p>5 PCS/ BUNDLE (80 FT)</p>



ROLLER/ ZEBRA™ SHADE COMPONENTS

All prices are subject to change without notice

FEB 16, 2024

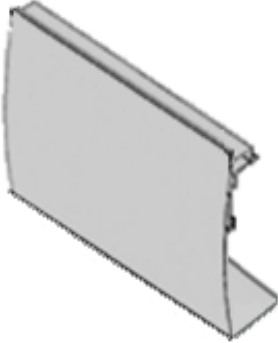
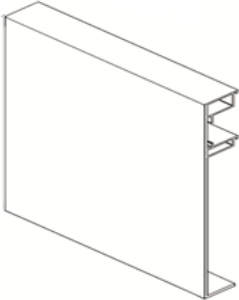
 <p>10</p>	<p>R-UF-C4F-XX</p>	<p>4" CURVED UNI-FACE™ FASCIA (16 FT) (ALUMINUM) 44mm bottom return</p> <p>*SAME Endcap R-UF-C4EC-XX as 4" Curved UNI-Face</p> <p>Optional Curved 4" Decorative Face with no Fabric Insert Channel</p> <p>USE with UNIFACE CLIP (R-UFC-S)</p> <p><u>Available Color (XX)</u> (SW) Snow White, (IV) Ivory, (BN) Brown, (BK) Black</p> <p>US Patent 9,617,785 B2 Taiwan Patent 495169, M499168 & M519934 Chinese Patent CN 2040970765U Chinese Patent CN 204015899U Chinese Patent CN 204212673U</p>	<p>4 PCS/ BUNDLE (64 FT)</p>
 <p>10</p>	<p>*NEW 2021*</p> <p>R-UF-F5F-XX</p>	<p>5" FLAT UNI-FACE™ FASCIA (16 FT) (ALUMINUM) NEW ** 12.7mm bottom return</p> <p>Duo shade uses bracket R-IB23D-S-(EZ or GL)-XX</p> <p>USE with UNIFACE CLIP (R-UFC-S2) Trim R-UF-F6.5EC-XX length for endcap</p> <p>5" Flat Smooth Face with no Fabric Insert Channel</p> <p><u>Available Color (XX)</u> (SW) Snow White, (IV) Ivory, (BK) Black</p> <p>US Patent 9,617,785 B2 Taiwan Patent 495169, M499168 & M519934 Chinese Patent CN 2040970765U Chinese Patent CN 204015899U Chinese Patent CN 204212673U</p>	<p>4 PCS/BUNDLE</p>



ROLLER/ ZEBRA™ SHADE COMPONENTS

All prices are subject to change without notice

FEB 16, 2024

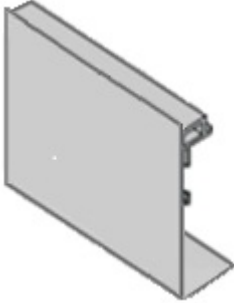
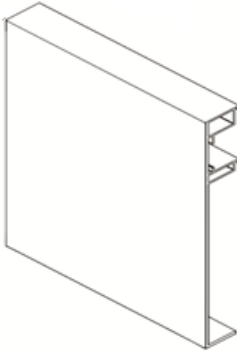
	<p>*NEW 2021*</p> <p>R-UF-F5F-XX-NEW</p>	<p>5" FLAT UNI-FACE™ FASCIA (16 FT) (ALUMINUM) NEW ** 12.7mm bottom return</p> <p>Duo shade uses bracket R-IB23D-S-(EZ or GL)-XX</p> <p>USE with UNIFACE CLIP (R-UFC-S2) Trim R-UF-F6.5EC-XX length for endcap</p> <p>5" Flat Smooth Face with no Fabric Insert Channel</p> <p><u>Available Color (XX)</u> (SW) Snow White</p> <p>US Patent 9,617,785 B2 Taiwan Patent 495169, M499168 & M519934 Chinese Patent CN 2040970765U Chinese Patent CN 204015899U Chinese Patent CN 204212673U</p>	<p>4 PCS/BUNDLE</p>
<p>10</p> 	<p>*NEW 2021*</p> <p>R-UF-F6.5F-XX</p>	<p>6.5" FLAT UNI-FACE™ FASCIA (16 FT) (ALUMINUM) NEW ** 12.7mm bottom return</p> <p>Duo shade uses bracket R-IB23D-L-(EZ or GL)-XX</p> <p>USE with UNIFACE CLIP (R-UFC-S2) Use R-UF-F6.5EC-XX for endcap</p> <p>6.5" Flat Smooth Face with no Fabric Insert Channel</p> <p><u>Available Color (XX)</u> (SW) Snow White, (IV) Ivory, (BK) Black</p> <p>US Patent 9,617,785 B2 Taiwan Patent 495169, M499168 & M519934 Chinese Patent CN 2040970765U Chinese Patent CN 204015899U Chinese Patent CN 204212673U</p>	<p>4 PCS/BUNDLE</p>



ROLLER/ ZEBRA™ SHADE COMPONENTS

All prices are subject to change without notice

FEB 16, 2024

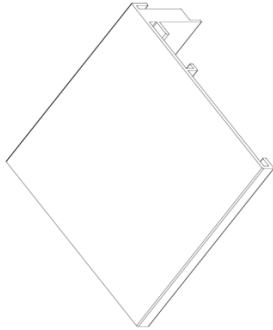
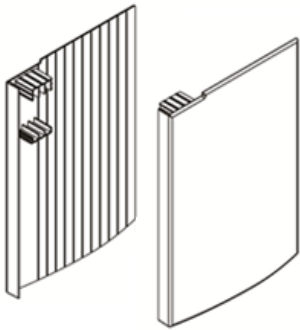
	<p style="text-align: center;">*NEW 2021*</p> <p style="text-align: center;">R-UF-F6.5F-XX-NEW</p>	<p>6.5" FLAT UNI-FACE™ FASCIA (16 FT) (ALUMINUM) NEW ** 12.7mm bottom return</p> <p>Able to do Fabric Wraps. -Please use R-M-T-PI-8T insert R-M-T-DS for the top</p> <p>Duo shade uses bracket R-IB23D-L-(EZ or GL)-XX</p> <p>USE with UNIFACE CLIP (R-UFC-S2) Use R-UF-F6.5EC-XX for endcap</p> <p>6.5" Flat Smooth Face with no Fabric Insert Channel</p> <p><u>Available Color (XX)</u> (SW) Snow White</p> <p>US Patent 9,617,785 B2 Taiwan Patent 495169, M499168 & M519934 Chinese Patent CN 2040970765U Chinese Patent CN 204015899U Chinese Patent CN 204212673U</p>	<p style="text-align: center;">4 PCS/BUNDLE</p>
 <p style="text-align: left;">10</p>	<p style="text-align: center;">R-UF-F6.5EC-XX</p>	<p>6.5" UNI-FACE™ END CAP (L/R) For new 5" & 6.5" Fascias</p> <p>5.5" returns scored at 5/16 intervals to customize return length. Trim actual length for 5" fascia</p> <p><u>Available Colors: (XX)</u> (SW) Snow White, (IV) Ivory, (BK) Black</p> <p>US Patent 7857034B2 Taiwan Patent 495169 Chinese Patent CN 204015899U</p>	<p style="text-align: center;">25 SETS / BAG</p> <p style="text-align: center;">100 SETS / BOX</p>



ROLLER/ ZEBRA™ SHADE COMPONENTS

All prices are subject to change without notice

FEB 16, 2024

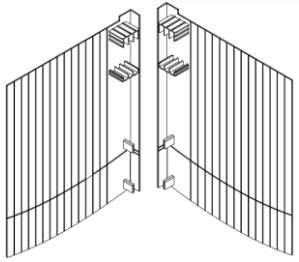
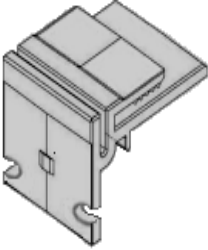
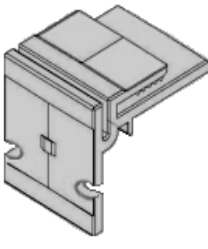
	<p>R-UF-F6.5EC-XX-NEW</p>	<p>6.5" UNI-FACE™ END CAP (L/R) For new 5" & 6.5" Fascias This is for R-UF-F6.5F-XX-NEW 5.5" returns scored at 5/16 intervals to customize return length. Trim actual length for 5" fascia</p> <p><u>Available Colors: (XX)</u> (SW) Snow White,</p> <p>US Patent 7857034B2 Taiwan Patent 495169 Chinese Patent CN 204015899U</p>	<p>25 SETS / BAG</p> <p>100 SETS / BOX</p>
<p>10</p> 	<p>R-UFC-S2</p>	<p>UNI-FACE™ SHORT CLIP (27mm)</p> <p>Use with Duo Bracket R-IB23D-(EZ or GL)-XX to connect Uni-Face™ Fascia R-UF-F5F-XX or Duo Bracket R-IB23D-L-(EZ or GL)-XX to connect Uni-Face™ Fascia R-UF-F6.5F-XX to the UNI-System™</p> <p>US Patent 9,617,785 B2 Taiwan Patent 495169 & M4991689 Chinese Patent CN 204015899U Chinese Patent CN 204212673U</p>	<p>100 PCS / BAG</p> <p>3000 PCS / BOX</p>
<p>10</p> 	<p>R-UFC-S</p>	<p>UNI-FACE™ CLIP (29mm)</p> <p>Use to connect any Uni-Face™ or Fauxwood Valances to the UNI-System™</p> <p>US Patent 9,617,785 B2 Taiwan Patent 495169 & M4991689 Chinese Patent CN 204015899U Chinese Patent CN 204212673U</p>	<p>100 PCS / BAG</p> <p>3000 PCS / BOX</p>



ROLLER/ ZEBRA™ SHADE COMPONENTS

All prices are subject to change without notice

FEB 16, 2024

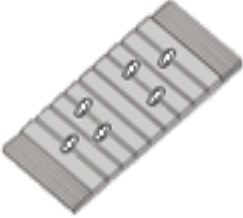
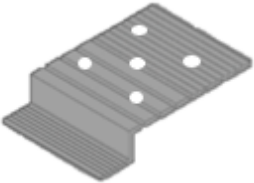
 <p>10</p>	<p>R-UF-OMA-XX</p>	<p>UNI-FACE OMNI ADAPTOR Use to attach a UNI Face with no UNI-Rail or UNI-Cassette</p> <p>Pre-drilled 3/16 holes 4.75" lengths, 2" width</p> <p><u>Available Colors:</u> ((BK) Black, (BN) Brown, (IV) Ivory, (SW) Snow White,</p> <p>U.S. Patent D811,124 S Taiwan Patent M520335 Chinese Patent CN 205012899U Chinese Patent CN 205558761U</p>	<p>10 PCS / BAG</p>
 <p>10</p>	<p>R-UF-OMAS-XX</p>	<p>UNI-FACE STEPPED OMNI ADAPTOR Use to attach a UNI Face with no UNI-Rail or UNI-Cassette, 2" x 4"</p> <p>5 pre-drilled 3/16 holes</p> <p><u>Available Colors:</u> (BK) Black, (BN) Brown, (IV) Ivory, (SW) Snow White</p> <p>U.S. Patent D811,124 S Taiwan Patent M520335 Chinese Patent CN 205012899U Chinese Patent CN 205445431U</p>	<p>10 PCS / BAG</p>



ROLLER/ ZEBRA™ SHADE COMPONENTS

All prices are subject to change without notice

FEB 16, 2024

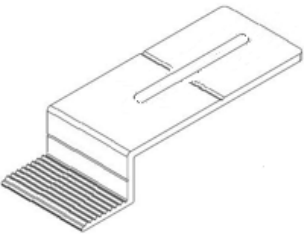
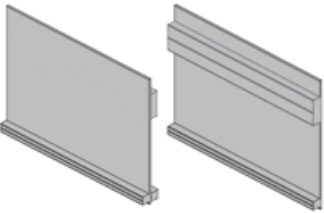
 <p>10</p>	<p>*NEW* R-UF-OMS-1.5A-SW</p>	<p>UNI-FACE ADJUSTABLE STEPPED OMNI ADAPTOR Use to attach a UNI Face with no UNI-Rail or UNI-Cassette, 1.5" x 2.25"</p> <p>Aluminum with 4.6mm wide by 1.375" long slot</p> <p><u>Available Colors:</u> (SW) Snow White</p> <p>U.S. Patent D811,124 S Taiwan Patent M520335 Chinese Patent CN 205012899U Chinese Patent CN 205445431U</p>	<p>10 PCS / BAG</p>
 <p>10</p>	<p>GEN-FVAL-4-WW</p>	<p>GENESIS 4" <u>FLAT SMOOTH</u> VALANCE (9 FT) * FOAM PVC</p> <p>** DISCONTINUED 08/23/2019**</p> <p><u>Available Colors:</u> (WW) White/ White</p> <p>US Patent D933 999 S</p>	<p>40 PCS/BUNDLE (360 FT)</p>



ROLLER/ ZEBRA™ SHADE COMPONENTS

All prices are subject to change without notice

FEB 16, 2024

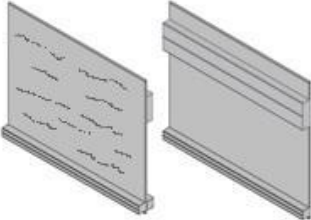
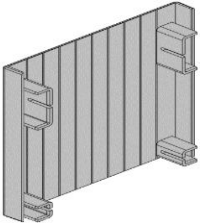
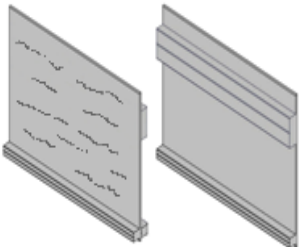
 <p>10</p>	<p>GEN-FVAL-4T-AW</p>	<p>GENESIS 4" <u>FLAT TEXTURED</u> VALANCE (9 FT) * FOAM PVC</p> <p>USE with UNIFACE CLIP (R-UFC-S)</p> <p><u>Available Colors:(XX)</u> (AW) Antique White</p> <p>US Patent D933 999 S</p>	<p>40 PCS/BUNDLE (360 FT)</p>
 <p>10</p>	<p>GEN-FVAL-4EC-W</p>	<p>GENESIS 4" FLAT END CAP VALANCE Inner scored</p> <p>Use 8mm screw WC-S-05 (Not included)</p> <p><u>Available Colors: (X)</u> (W) White</p> <p>US Patent 7857034B2</p>	<p>50 PCS / BAG 400 PCS/ BOX</p>
 <p>10</p>	<p>GEN-FVAL-5T-AW</p>	<p>GENESIS 5" <u>FLAT TEXTURED</u> VALANCE (9 FT) * FOAM PVC</p> <p>USE with UNIFACE CLIP (R-UFC-S)</p> <p><u>Available Colors:(XX)</u> (AW) Antique White</p> <p>US Patent D933 999 S Taiwan Patent M576027</p>	<p>40 PCS/ BUNDLE (360 FT)</p>



ROLLER/ ZEBRA™ SHADE COMPONENTS

All prices are subject to change without notice

FEB 16, 2024

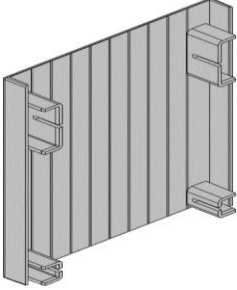
 <p>10</p>	<p>GEN-FVAL-5EC-W</p>	<p>GENESIS 5" FLAT END CAP VALANCE Inner scored</p> <p>Use 8mm screw WC-S-05 (Not included)</p> <p><u>Available Colors:</u> (X) (W) White</p> <p>US Patent 7857034B2</p>	<p>50 PCS / BAG</p> <p>400 PCS / BOX</p>
--	------------------------------	--	--

PRIVACY SIDE CHANNEL 11

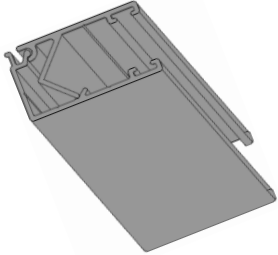
<p>*DISCONTINUED* (April 2019, limited inventory)</p>  <p>11</p>	<p>R-PCH-U-XX</p>	<p>2- PIECE SET ALUMINUM PRIVACY CHANNEL, 16FT</p> <p>W 1 3/4", D 1" with 1/2" clear space interior Hem Pocket Bottom rail</p> <p><u>Available Colors:</u> (OW) Off-White, (SI) Silver, (BK) Black</p>	<p>4 SETS/BUNDLE (64 FT)</p>
---	--------------------------	---	--



ROLLER/ ZEBRA™ SHADE COMPONENTS

All prices are subject to change without notice

FEB 16, 2024

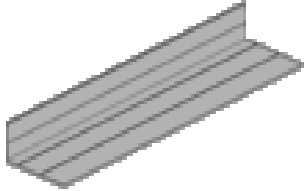
<p>*DISCONTINUED*</p>  <p>11</p>	<p>R-PCH-B-BK</p>	<p>PRIVACY CHANNEL SOFT BRUSH INSERT, 20FT Inside front and back to guide and further reduce light leakage.</p> <p>Use with the Side Channel (R-PCH-U-XX)</p> <p><u>Available Colors:</u> (BK) Black ONLY</p>	<p>20 FT / BAG *(Minimum)</p>
 <p>11</p>	<p>R-PCS-U-XX</p>	<p>UNIVERSAL SINGLE LIGHT GAP RAIL 1-3/4" X 3/4", 16FT</p> <p>Use to cover shade light gaps at the sides</p> <p><u>Available Color (XX):</u> (BK) Black, (SW) Snow White, <u>Available Discontinued Color (XX):</u> (BN) Bronze, (IV) Ivory</p>	<p>10 PCS/BUNDLE (160 FT)</p>



ROLLER/ ZEBRA™ SHADE COMPONENTS

All prices are subject to change without notice

FEB 16, 2024

SPRING ASSIST LIFT 12

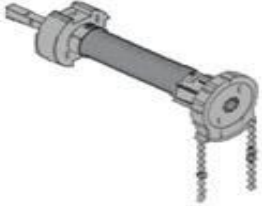
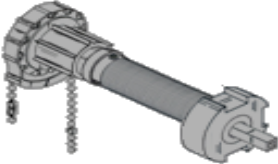
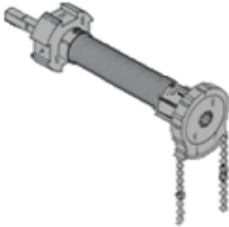
 <p>12</p>	<p>R-SA12-1.5REZXX (for 1-5/8" Tube)</p>	<p>ASSEMBLED RIGHT SPRING ASSIST FOR 12 LB 32 BALL EZ CLUTCH & <u>1-5/8" TUBE</u></p> <p><u>Available Color - EZ ROLL CLUTCH (XX):</u> (BK) Black, (SW) Snow White</p> <p>End plug & chain not included</p>	<p>1 PC / BAG</p>
 <p>12</p>	<p>R-SA12-1.5LEZXX (for 1-5/8" Tube)</p>	<p>ASSEMBLED LEFT SPRING ASSIST FOR 12 LB 32 BALL EZ CLUTCH & <u>1.625" TUBE</u></p> <p><u>Available Color - EZ ROLL CLUTCH (XX):</u> (BK) Black, (SW) Snow White</p> <p>End plug & chain not included</p>	<p>1 PC / BOX</p>
 <p>12</p>	<p>R-SA16-2REZXX (for 2" Tube)</p>	<p>ASSEMBLED RIGHT SPRING ASSIST FOR 16 LB 32 BALL EZ CLUTCH & <u>2" TUBE</u></p> <p><u>Available Color - EZ ROLL CLUTCH (XX):</u> (BK) Black, (SW) Snow White</p> <p>End plug & chain not included</p>	<p>1 PC / BOX</p>



ROLLER/ ZEBRA™ SHADE COMPONENTS

All prices are subject to change without notice

FEB 16, 2024

<p>12</p> 	<p>R-SA16-2LEZXX (for 2" Tube)</p>	<p>ASSEMBLED LEFT SPRING ASSIST FOR 16 LB 32 BALL EZ CLUTCH & 2" TUBE</p> <p>White or Black EZ Roll Clutch</p> <p>End plug & chain not included</p>	<p>1 PC / BOX</p>
<p>12</p> 	<p>R-SA24-2.5REZXX (for 2.5" Tube)</p>	<p>ASSEMBLED RIGHT SPRING ASSIST FOR 24 LB 32 BALL EZ CLUTCH & 2.5" TUBE</p> <p><u>Available Color - EZ ROLL CLUTCH (XX):</u> (BK) Black, (SW) Snow White</p> <p>End plug & chain not included</p>	<p>1 PC / BOX</p>
<p>12</p> 	<p>R-SA24-2.5LEZXX (for 2.5" Tube)</p>	<p>ASSEMBLED LEFT SPRING ASSIST FOR 24 LB 32 BALL EZ CLUTCH & 2.5" TUBE</p> <p><u>Available Color - EZ ROLL CLUTCH (XX):</u> (BK) Black, (SW) Snow White</p> <p>End plug & chain not included</p>	<p>1 PC / BOX</p>



ROLLER/ ZEBRA™ SHADE COMPONENTS

All prices are subject to change without notice

FEB 16, 2024



FOR STANDARD ROLLER SHADES

Chart shows suggested turns for that clutch. **Less weight requires fewer turns.**

BALL SIZE	CLUTCH WEIGHT EZ or GL	SIDE L or R	TUBE SIZE	ROTATIONS	DIRECTION
23	10 LB	R	1 5/8"	0	CCW
23	10 LB	L	1 5/8"	0	CW
32	12 LB	R	1 5/8"	0	CCW
32	12 LB	L	1 5/8"	0	CW
32	16 LB	R	2"	5	CCW
32	16 LB	L	2"	5	CW
32	24 LB	R	2 1/2"	10	CCW
32	24 LB	L	2 1/2"	10	CW

FOR REVERSE ROLLER SHADES

Chart shows suggested turns for that clutch. **Less weight requires fewer turns.**

BALL SIZE	CLUTCH WEIGHT EZ or GL	SIDE L or R	CLUTCH SIDE TO BUY	TUBE SIZE	ROTATIONS	DIRECTION
23	10 LB	R	L	1 5/8"	0	CCW
23	10 LB	L	R	1 5/8"	0	CW
32	12 LB	R	L	1 5/8"	0	CCW
32	12 LB	L	R	1 5/8"	0	CW
32	16 LB	R	L	2"	5	CCW
32	16 LB	L	R	2"	5	CW
32	24 LB	R	L	2 1/2"	10	CCW
32	24 LB	L	R	2 1/2"	10	CW



ROLLER/ ZEBRA™ SHADE COMPONENTS

All prices are subject to change without notice

FEB 16, 2024

TAPES/INSERTS/SPLINE 13

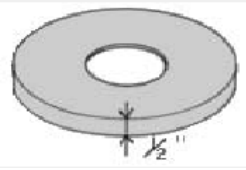
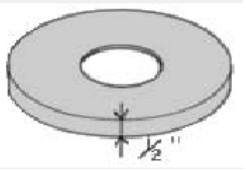
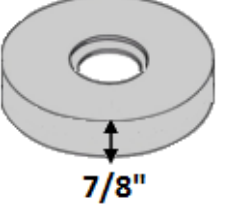
 <p>13</p>	<p>R-WTAPE</p>	<p>5/16" (8mm) FABRIC WELDING TAPE, CLEAR, Light Adhesive</p>	<p>26 YDS / ROLL</p>
 <p>13</p>	<p>R-M-T-DS R-M-T-DS-60</p>	<p>1/2" DOUBLE FACE TAPE Attaches Fabric To Tube</p> <p>R-M-T-DS: 55 yards R-M-T-DS-60: 60 yards (Clear Glue)</p>	<p>55 YDS / ROLL (165 FT)</p>
 <p>13</p>	<p>** NEW ** R-M-T.5A-DS</p>	<p>New 1/2" Double Sided Tape with aggressive Acrylic adhesive.</p> <p>Good to adhere fabric to flat smooth fascia & UNI-Face</p>	<p>55 YDS/ ROLL (165 FT)</p>
 <p>13</p>	<p>R-M-T.875-DS R-M-T.875-DS-60</p>	<p>7/8" DOUBLE FACE TAPE Attaches Zebra Fabric To Tube</p> <p>R-M-T.875-DS: 55 yards R-M-T.875-DS-60: 60 yards</p>	<p>55 YDS/ ROLL (165 FT)</p>



ROLLER/ ZEBRA™ SHADE COMPONENTS

All prices are subject to change without notice

FEB 16, 2024

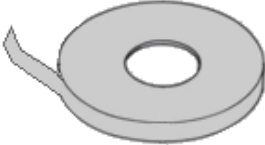
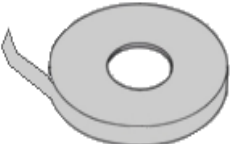
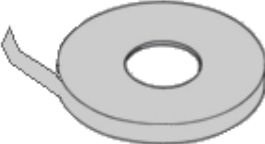
<p>** NEW 2019 **</p>  <p>13</p>	<p>R-M-T-PI-9T</p>	<p>PLASTIC INSERT ABS (0.4mm x 6.5mm)</p> <p>Use with double sided tape to lock fabric in HALF WRAPPED Elliptical BOTTOM RAIL</p>	<p>500M/ ROLL (1,640 FT)</p>
 <p>13</p>	<p>R-M-T-PI-4T</p>	<p>PLASTIC INSERT (0.4mm x 8mm)</p> <p>Use a piece on both sides of sheer fabric stripe for locking Zebra fabric in 1-5/8" Top Tube</p>	<p>656 FT / ROLL</p>
 <p>13</p>	<p>R-M-T-PI-7T</p>	<p>PLASTIC INSERT (0.4mm x 9mm)</p> <p>For locking fabric in Mini Bottom rail Use with thick fabrics</p>	<p>656 FT / ROLL</p>
 <p>13</p>	<p>R-M-T-PI-5T</p>	<p>PLASTIC INSERT (0.4mm x 11mm)</p> <p>Use a piece on both sides of sheer fabric stripe to lock Zebra fabric in Cassette</p>	<p>656 FT / ROLL</p>



ROLLER/ ZEBRA™ SHADE COMPONENTS

All prices are subject to change without notice

FEB 16, 2024

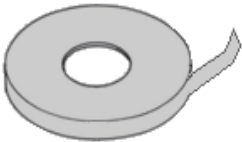
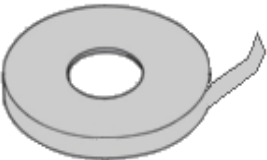
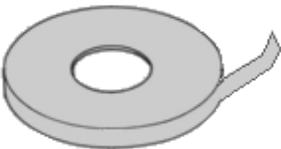
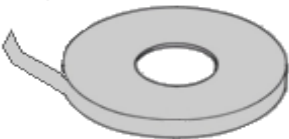
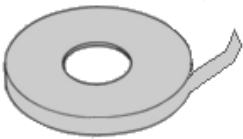
 13	R-M-T-PI-8T	PLASTIC INSERT (0.8mm x 5mm) For locking fabric in Slender Bottom rail Use with thin fabrics	328 FT / ROLL
 13	R-M-T-PI-1T	PLASTIC INSERT (0.8mm x 8mm) With adhesive to lock fabric to the 1- 5/8" Top Tube	328 FT / ROLL
 13	R-M-T-PI-6T	PLASTIC INSERT (0.8mm x 9mm) For locking fabric in Mini Bottom rail Use with thin fabrics	328 FT / ROLL
 13	R-M-T-PI-2T	PLASTIC INSERT (0.8mm x 11mm) With adhesive to lock fabric in Cassette	328 FT / ROLL
 13	R-M-T-PI-3T	PLASTIC INSERT (0.8mm x 14mm) With adhesive side to lock fabric and/or wrapping Elliptical and Round Bottom Rail	328 FT / ROLL



ROLLER/ ZEBRA™ SHADE COMPONENTS

All prices are subject to change without notice

FEB 16, 2024

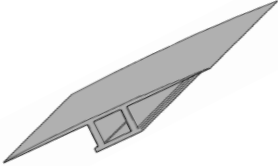
 <p>13</p>	<p>R-M-T-WPS</p>	<p>CLEAR PLASTIC SPLINE Use on 1-5/8" and 2 1/2" TUBE</p> <p>Width: 1 " Thickness: 3/16" Ultrasonic welded to material for easy attachment to TUBE</p>	<p>500 FT / ROLL</p>
--	-------------------------	---	-----------------------------

TUBES 14

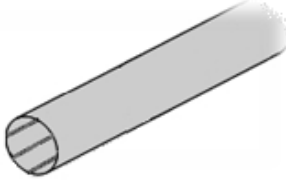
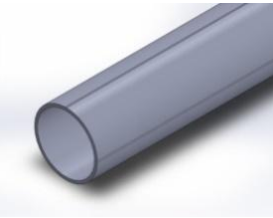
 <p>14</p>	<p>R-T3-U-.75-12</p>	<p>MINI EZ SHADE 3/4" TUBE (12 FT)</p> <p>Use with Mini EZ, Mini EZ-Matic and as optional back Zebra fabric adjuster</p> <ul style="list-style-type: none"> • Max shade width 4 FT • Holds up to 3 Lbs 	<p>20 PCS / BUNDLE (240 FT)</p>
<p>*DISCONTINUED*</p>  <p>14</p>	<p>R-T5-U-1.125</p>	<p>UNIVERSAL ANODIZED 1-1/8" TUBE (16 FT) ALUMINUM</p> <p>Inside Diameter 26.8mm (1 1/16") Outside Diameter 28.6mm (1 1/8")</p> <ul style="list-style-type: none"> • Max shade width 4 FT • Holds up to 5 Lbs 	<p>10 PCS / BUNDLE (160 FT)</p>



ROLLER/ ZEBRA™ SHADE COMPONENTS

All prices are subject to change without notice

FEB 16, 2024

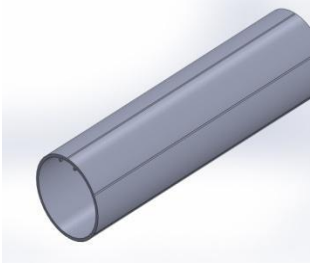
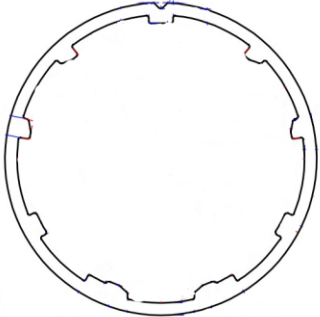
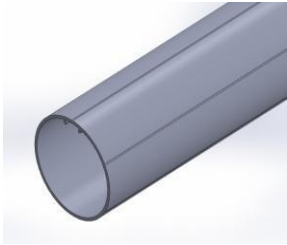

 <p>14</p>	<p>R-T8-U-1.25 NEW</p>	<p>UNIVERSAL ANODIZED 1-¼" TUBE (16 FT) ALUMINUM</p> <p>Inside Diameter 30.2mm (1 3/16") Outside Diameter 31.75mm (1 ¼ ")</p> <ul style="list-style-type: none"> • Max shade width 6 FT • Holds up to 8 LBS 	<p>10 PCS / BUNDLE (160 FT)</p>
	<p>GEN-T8-U-1.25NC</p>	<p>Genesis ANODIZED 1-¼" TUBE (16 FT) ALUMINUM</p> <ul style="list-style-type: none"> • Max shade width 6 FT • Holds up to 8 LBS 	<p>10 PCS / BUNDLE (160 FT)</p>
 <p>14</p>	<p>R-T10-U-1.5</p>	<p>UNIVERSAL ANODIZED 1- ½" TUBE (16 FT) ALUMINUM</p> <p>Inside Diameter 36mm (1.43") Outside Diameter 38mm (1 ½ ")</p> <ul style="list-style-type: none"> • Max shade width 7 FT • Holds up to 10 Lbs 	<p>10 PCS/BUNDLE (160 FT)</p>



ROLLER/ ZEBRA™ SHADE COMPONENTS

All prices are subject to change without notice

FEB 16, 2024

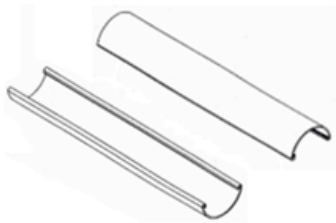
  <p>14</p>	<p>R-T12-2G-1.625 (Anodized Silver)</p> <p>R-T12-2G-1.625-SW (Painted White)</p>	<p>UNIVERSAL ANODIZED 1-5/8" TUBE with 2 GROOVES (16 FT) ALUMINUM (Preferred tube for Zebra & Roman shades)</p> <p>Inside Diameter 37.7mm (1-15/32") Outside Diameter 40.4mm (1- 5/8 ")</p> <ul style="list-style-type: none"> ● Max shade width 8 FT ● Holds up to 12 Lbs <p>Available in Anodized Silver and Painted White</p>	<p>10 PCS / BUNDLE (160 FT)</p>
 <p>14</p>	<p>R-T12-1.625- DUOARC-W</p>	<p>12 LB, SINGLE DUO ARC SECTION (half tube) - 9 FT</p> <p>Use with double groove 1.625" tube</p>	<p>20 PCS/Bundle</p>



ROLLER/ ZEBRA™ SHADE COMPONENTS

All prices are subject to change without notice

FEB 16, 2024

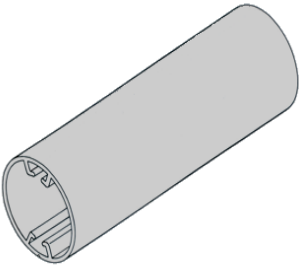
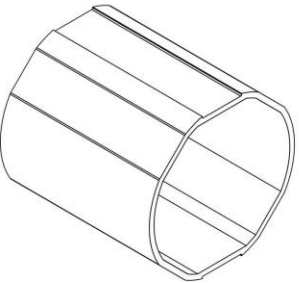
 <p>14</p>	<p>R-T12-CD1-1.625</p>	<p>UNIVERSAL ANODIZED 1- 5/8" TUBE with 2 INTERNAL GROOVES (16 FT) ALUMINUM</p> <p>(Use for EZ-MATIC CORDLESS)</p> <p>Inside Diameter 37.7mm (1 15/32") Outside Diameter 40.4mm (1 5/8 ")</p> <ul style="list-style-type: none"> • Max shade width 8 FT • Holds up to 12 Lbs <p>U.S. Patent D874.184 S</p>	<p>10 PCS / BUNDLE (160 FT)</p>
 <p>14</p>	<p>GEN-T16-1.625SPLICER</p>	<p><u>GENESIS TUBES SPLICER</u> <u>1.625inch</u></p> <p>This is used to combine Gen-T16-2G-1.625 tubes.</p> <p>RI-02 is required to connect the tubes to the splicer.</p>	<p>10 pcs / Bundle 16ft</p>



ROLLER/ ZEBRA™ SHADE COMPONENTS

All prices are subject to change without notice

FEB 16, 2024

 14	GEN-T20-2-SPLICER	<u>GENESIS TUBES SPLICER 2 inch</u> This is used to combine GEN-T20-2 tubes. RI-02 is required to connect the tubes to the splicer.	6 pcs / Bundle 16ft
--	--------------------------	--	--------------------------------



ROLLER/ ZEBRA™ SHADE COMPONENTS

All prices are subject to change without notice

FEB 16, 2024

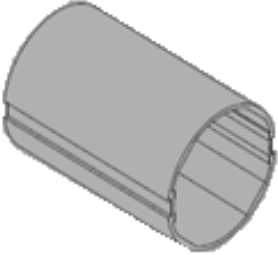
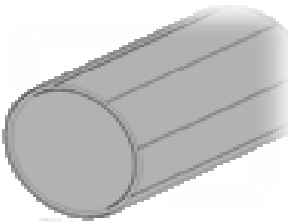
 <p>14</p>	<p>GEN-T16-2G-1.625</p>	<p><u>GENESIS TUBES</u></p> <p>GENESIS 1-5/8" TUBE, with 2 GROOVES, ALUMINUM, 16FT</p> <p><i>**Carries more weight & greater shade widths than standard 1-5/8" tube while substantially under the 2" tube cost.</i></p> <p>Inside Diameter: 37.5mm (1-31/64") Outside Diameter: 40.4mm (1-5/8")</p> <ul style="list-style-type: none"> ● Max Shade Width 10 FT ● Holds up to 16 LBS ● Max 121 SQFT <p>Available: Anodized Silver and Painted White Finish (Specify)</p> <p>Use with Genesis motor, EZ Clutch with GEN-1.625 ADAPTOR. The Genesis Spring Assist & EZ- Matic (cordless) not available at this time.</p> <p>MUST USE Genesis End Plug GEN-EP1.625-XX U.S. Patent Pending</p>	<p>10 PCS / BUNDLE (160 FT)</p>
 <p>14</p>	<p>Discontinued</p> <p>R-T16-M-2</p>	<p><u>UNIVERSAL 2" TUBE FOR MOTORIZATION, ALUMINUM ANODIZED, 16FT</u></p> <p>Inside Diameter: 46.7mm (1.8") Outside Diameter: .50.8mm (2")</p> <p>Notch size 20mm long x 5mm wide Use Spring Pin to SET motor to tube</p> <ul style="list-style-type: none"> ● Max shade width 10 FT ● Holds up to 16 Lbs 	<p>5 PCS/ BUNDLE (80 FT)</p>



Main Office: 620 S. Jefferson St. Unit A, Placentia, CA 92870 Tel (800) 441-2024 Fax (800) 787-5369
 4570 Shelby Air Dr. Suite 6, Memphis, TN 38118 Tel (901) 360-0058 Fax (901) 365-3007



ROLLER/ ZEBRA™ SHADE COMPONENTS

All prices are subject to change without notice

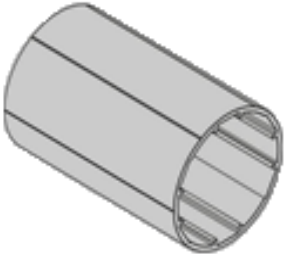
FEB 16, 2024

 <p>14</p>	<p>GEN-T20-2</p>	<p><u>GENESIS TUBES</u></p> <p>GENESIS 2" TUBE, ANODIZED ALUMINUM, 16FT</p> <p><i>**Carries more weight & greater shade widths than standard 2" tube while substantially under cost.</i></p> <p>Inside Diameter: 47.8mm (1.88") Outside Diameter: 50.8mm (2")</p> <ul style="list-style-type: none"> ● Max Shade Width 14 FT ● Hold up to 20 Lbs ● Max 140 SQFT <p>Use with Genesis motor, EZ Clutch with R-TA-U adaptor. The Genesis Spring Assist & EZ- Matic (cordless) not available at this time. Use standard end plug R-EPLG-XX <i>U.S. Patent Pending</i></p>	<p>4 PCS / BNDL (64FT)</p> <p>** UPDATED **</p>
<p>*DISCONTINUED* (Limited inventory)</p>  <p>14</p>	<p>R-T20-U-2.25</p> <p>**DISCOUNT PRICE</p>	<p>UNIVERSAL ANODIZED 2-1/4" TUBE (16 FT) ALUMINUM</p> <p>Inside Diameter 46.6mm (1.84") Outside Diameter 57.2mm (2.25")</p> <ul style="list-style-type: none"> ● Max shade width 11.5 FT ● Holds up to 20 Lbs <p>Use two R-TA-U-XX adaptors (clutch & end plug)</p>	<p>10 PCS / BUNDLE (160 FT)</p>



ROLLER/ ZEBRA™ SHADE COMPONENTS

All prices are subject to change without notice

FEB 16, 2024

 <p>14</p>	<p>2018 *IMPROVED*</p> <p>R-T24-U-2.5M</p>	<p>UNIVERSAL ANODIZED 2-1/2" TUBE (20 FT) ALUMINUM</p> <p>Inside Diameter 46.6mm (1.84") Outside Diameter 63.5mm (2.5")</p> <ul style="list-style-type: none"> • Max shade width 13 FT • Holds up to 24 Lbs <p><u>Standard Shade</u> Uses two R-TA-U-XX adaptors (clutch & end plug)</p> <p><u>Spring Assist Shade</u> Must use one Tube Adaptor (R-TA-U-2.5)</p> <p><u>AC Motor Shade</u> Must use Crown (MRS-MA-C2.5CC-Part A) See in Motorization</p>	<p>3 PCS / BUNDLE (48 FT)</p>
--	--	---	--------------------------------------



ROLLER/ ZEBRA™ SHADE COMPONENTS

All prices are subject to change without notice

FEB 16, 2024

UNI PLATFORMS (UNI-Rail™ & UNI-Cassette™) 15

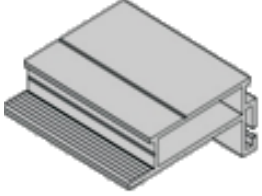
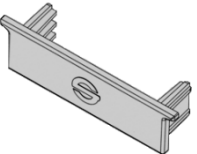
 <p>15</p>	<p>R-URA-XX/R-URA-XX-NEW</p>	<p>UNI-Rail™ A BASE (16 FT)</p> <p>For 23 Ball Clutches</p> <p>Uses mounting clip SC-02AS Clip Zebra Channel at rear</p> <p><u>Available Colors:</u> (BK) Black, (BN) Brown, (IV) Ivory (SW) Snow White</p> <p>US Patent 9,617,785 B2 Taiwan Patent 495169, M499168, M519934 Chinese Patent CN 204015899U Chinese Patent CN 204212673U Chinese Patent CN 204970765U</p>	<p>8 PCS / BUNDLE</p>
 <p>15</p>	<p>R-URA-P-XX</p>	<p>UNI RAIL A END PLUG</p> <p><u>Available Colors:</u> (BK) Black, (BN) Brown, (IV) Ivory, (SW) Snow White</p> <p>US Patent 9,617,785 B2 Taiwan Patent 495169 Chinese Patent CN 204015899U</p>	<p>100 PCS / BAG 3000 PCS / BOX</p>



ROLLER/ ZEBRA™ SHADE COMPONENTS

All prices are subject to change without notice

FEB 16, 2024

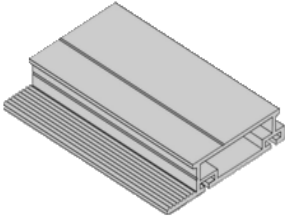
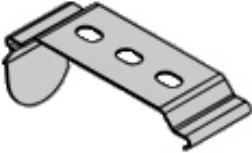

<p>15</p>  <p>SC-02AS</p>	<p>SC-02AS</p>	<p>UNI-RAIL™ A BASE MOUNTING CLIP</p>	<p>1000 PCS / BAG 2000 PCS / BOX</p>
<p>15</p> 	<p>R-URC-XX</p>	<p>UNI-Rail™ C BASE (16 FT) For 23 & 32 Ball Clutches</p> <p>Uses mounting clip R-URBC-MC Zebra Channel on bottom</p> <p>(BK) Black, (BN) Brown, (IV) Ivory, (SW) Snow White</p> <p>US Patent 9,617,785 B2 Taiwan Patent 495169, M499168, M519934 Chinese Patent CN 204015899U Chinese Patent CN 204212673U Chinese Patent CN 204970765U</p>	<p>5 PCS / BUNDLE</p>
<p>15</p> 	<p>R-URC-P</p>	<p>UNI RAIL C END PLUG</p> <p><u>Available Colors:</u> Milky White</p> <p>US Patent 9,617,785 B2 Taiwan Patent 495169 Chinese Patent CN 204015899U</p>	<p>100 PCS / BAG 3000 PCS / BOX</p>
<p>15</p> 	<p>R-URBC-MC</p>	<p>UNI-Rail™ C BASE MOUNTING CLIP</p> <p>Used on R-URC-XX Short Tab</p>	<p>100 PCS / BAG</p>



ROLLER/ ZEBRA™ SHADE COMPONENTS

All prices are subject to change without notice

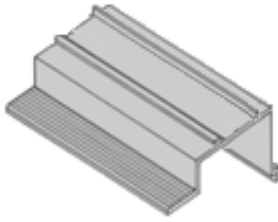
FEB 16, 2024

 <p>15</p>	<p>DISCONTINUED R-URCT2-XX</p>	<p>UNI-CASSETTE™ # 2, 16 FT</p> <p>Top 2 1/8" wide, 1 1/8" rear drop For 23 or 32 ball clutches Uses mounting clip R-URCT1-MC</p> <p><u>Available Colors:</u> (BK) Black, (BN) Brown, (IV) Ivory, (SW) Snow White</p> <p>US Patent 9,617,785 B2 Taiwan Patent 495169, M499168, M519934 Chinese Patent CN 204015899U Chinese Patent CN 204212673U Chinese Patent CN 204970765U</p>	<p>1 PC</p>
 <p>15</p>	<p>R-URCT1-MC</p>	<p>UNI-CASSETTE™ MOUNTING CLIP</p> <p>2 1/8" - zinc plated spring steel</p>	<p>25 PCS / BAG 500 / BOX</p>



ROLLER/ ZEBRA™ SHADE COMPONENTS

All prices are subject to change without notice

FEB 16, 2024

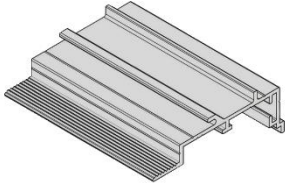
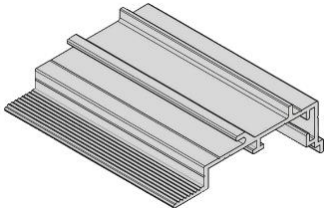
<p>UNI-CASSETTE # 4</p>  <p>REPLACING WITH UNI-CASSETTE # 5</p> <div style="border: 1px solid black; padding: 5px; width: fit-content; margin: 10px auto;"> <p>T-RAIL is 1.5mm forward</p> </div>  <p>15</p>	<p>R-URCT4-XX</p> <p>&</p> <p>R-URCT5-XX</p>	<p>UNI-CASSETTE # 4 & # 5 with T-RAIL & ZEBRA REAR CHANNEL, 16 FT</p> <p>Use mounting clip R-URCT1-MC</p> <p><u>Available Colors:</u> (BN) Brown, (IV) Ivory, (SW) Snow White (BK) Black</p> <p>Must use brackets: R-IB35UC-EZ23-XX, R-IB45UC-EZ23-XX, R-IB45UC-EZ32-XX</p> <p>US Patent 9,617,785 B2 Taiwan Patent 495169, M499168, M519934 Chinese Patent CN 204015899U Chinese Patent CN 204212673U Chinese Patent CN 204970765U</p>	<p>4 PCS / BUNDLE</p>
---	---	--	------------------------------



ROLLER/ ZEBRA™ SHADE COMPONENTS

All prices are subject to change without notice

FEB 16, 2024

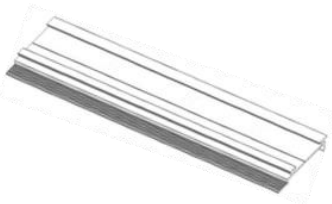
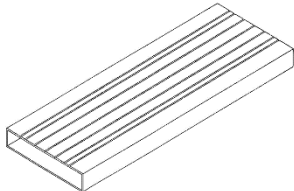
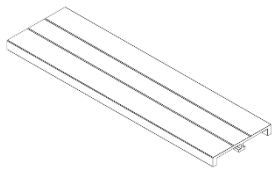
 <p>15</p>	<p>**NEW 2022**</p> <p>R-URCT9-XX</p>	<p>UNI-CASSETTE # 9 16 ft length Use mounting clip R-URBC-MC</p> <p><u>Available Colors:</u> (SW) Snow White</p> <p>US Patent 9,617,785 B2 Taiwan Patent 495169, M499168, M519934 Chinese Patent CN 204015899U Chinese Patent CN 204212673U Chinese Patent CN 204970765U</p>	<p>4 PCS / BUNDLE</p>
 <p>15</p>	<p>*NEW 2022*</p> <p>R-GRA-SW</p>	<p>BAR A - 16 Foot Long 2" x 3/8" Hollow Aluminum</p> <p>Uses Cassette2 section & R-UCT1-MC for mounting every 48"</p>	<p>5 PCS / BUNDLE</p>
 <p>15</p>	<p>*NEW 2022*</p> <p>R-GRB-SW</p>	<p>BAR B - 12-Foot-Long Aluminum 1 7/8" x 1/4" Hollow Aluminum</p> <p>Insert for Bar A or Stand alone</p> <p>Uses Cassette2 section & R-UCT1-MC for mounting every 24"</p> <p>US Patent Pending</p>	<p>10 PCS / BUNDLE</p>



ROLLER/ ZEBRA™ SHADE COMPONENTS

All prices are subject to change without notice

FEB 16, 2024

TOOLS/MACHINERY 16



 <p>16</p>	<p>R-T-CS</p>	<p>CLIPPER STAPLER</p> <p>Use with Tube/Cassette Plastic Insert To attach material to insert</p>	<p>1 PIECE</p>
 <p>16</p>	<p>R-T-CS-10S</p>	<p>#10 CLIPPER STAPLES BOX (1,000 STAPLES)</p> <p>For CLIPPER STAPLER -R-T-CS</p>	<p>20 BOXES/PACK</p>
 <p>16</p>	<p>R-T-MIT</p>	<p>MATERIAL INSERTION TOOL</p> <p>Assists inserting material into Round & Elliptical bottom rail</p> <p>Stainless Steel</p>	<p>1 PIECE</p>
 <p>16</p>	<p>T-FABWGT-S</p>	<p>FLAT WEIGHT FOR FABRIC TABLE 18"X2"X1/2", 6 LBS, WHITE</p>	<p>1 PIECE</p>



ROLLER/ ZEBRA™ SHADE COMPONENTS

All prices are subject to change without notice

FEB 16, 2024

 <p>16</p>	<p>T-FABWGT-L</p>	<p>FLAT WEIGHT FOR FABRIC TABLE 24"X5"X1/4", 9 LBS, WHITE</p>	<p>1 PIECE</p>
 <p>16</p>	<p>T-FSB-MNG</p>	<p>FASCIA & FASCIA SUPPORT BRACKET MANUAL CUT / NOTCH GUIDE</p>	<p>1 PIECE</p>
 <p>16</p>	<p>T-FAB-SGUIDE</p>	<p>FABRIC CUTTING TRACK (Made to order only)</p> <p>Includes: 2 x Shaft - 13FT, 2 x Shaft Support - 47 INCH 4 x Blocks</p>	<p>1 SET</p>

ROTARY FABRIC CUTTER & PARTS



ROLLER/ ZEBRA™ SHADE COMPONENTS

All prices are subject to change without notice

FEB 16, 2024





 <p>16</p>	<p>R-T-RFC-S</p>	<p>GENES ROTARY FABRIC CUTTER SET</p> <p>Includes: Rotary Cutter with installed 4 1/4" blade 1 Extra 4 1/4" Cutting Blade Power Cord</p> <p>Suggested to order with Cutter Guide 192" (R-T-RFC-GT) or the 96" (R-T-RFC-G96")</p>	<p>1 SET</p>
 <p>16</p>	<p>R-T-RFC-BL</p>	<p>ROTARY FABRIC CUTTER REPLACEMENT 4-1/4" BLADE</p>	<p>1 PIECE</p>
 <p>16</p>	<p>R-T-RFC-KNIFE</p>	<p>ROTARY FABRIC CUTTER REPLACEMENT LOW BLADE , 1-1/4" USE 2mm ALLEN WRENCH</p>	<p>1 PIECE</p>
 <p>16</p>	<p>R-T-RFC-BRUSH</p>	<p>ROTARY FABRIC CUTTER REPLACEMENT BRUSH SET</p>	<p>2 PCS / BAG</p>



ROLLER/ ZEBRA™ SHADE COMPONENTS

All prices are subject to change without notice

FEB 16, 2024

 <p>16</p>	<p>R-T-RFC-GRINDER</p>	<p>ROTARY FABRIC CUTTER REPLACEMENT BLADE GRINDER COMPLETE SET</p>	<p>1 SET / BAG</p>
 <p>16</p>	<p>R-T-RFC-GRINDER-1</p>	<p>ROTARY FABRIC CUTTER REPLACEMENT BLADE SHARPENING STONE WITH C- CLIP</p>	<p>1 PC / BAG</p>
 <p>16</p>	<p>R-T-RFC-GT</p>	<p>CUTTER GUIDE TRACK, 16FT 192" with Steel Insert</p>	<p>1 PIECE</p>
 <p>16</p>	<p>R-T-RFC-GT96"</p>	<p>CUTTER GUIDE TRACK, 8FT 96" with Steel Insert</p>	<p>1 PIECE</p>

SHADE CUTTER & PARTS



ROLLER/ ZEBRA™ SHADE COMPONENTS

All prices are subject to change without notice

FEB 16, 2024

 <p>16</p>	<p>R-T-GSC-2.75</p>	<p>SHADE CUTTER M755 (2.75" Max Roll Diameter)</p> <p>Includes: Cutter Blade Slide Bracket 120" V-bar with Tape Plug for 1-5/8" Alum Tube (For inner grooves Tube Only) 3 V-Bar Support</p>	<p>1 SET</p>
 <p>16</p>	<p>R-T-GSC-SBC-755</p>	<p>SHADE CUTTER M755 SLIDE BRACKET COMPLETE SET</p>	<p>1 PIECE</p>
 <p>16</p>	<p>R-T-GSC-MSB-LP</p>	<p>MID SUPPORT BRACKET LOLLIPOP, 2 1/4" I.D.</p> <p>Supports shades during cutting, avoids sagging, Must use for over 6FT shade</p>	<p>1 PIECE</p>



ROLLER/ ZEBRA™ SHADE COMPONENTS

All prices are subject to change without notice

FEB 16, 2024

 <p>16</p>	<p>R-T-GSC-MSB-LPL</p>	<p>MID SUPPORT BRACKET LOLLIPOP - LARGE, 2 3/4" I.D.</p> <p>Supports shades during cutting, avoids sagging</p>	<p>1 PIECE</p>
 <p>16</p>	<p>R-T-GSC-VBS-45A</p>	<p>V-BAR SUPPORT w/Screw</p> <p>Elevates V-Bar so Slide Bracket moves freely</p>	<p>1 PIECE</p>
 <p>16</p>	<p>R-T-GSC-VBE60</p>	<p>V-BAR EXTENSION 60" (OPPOSITE MAIN)</p> <p>Comes with measuring tape & pre-drilled holes for supports</p>	<p>1 PIECE</p>
 <p>16</p>	<p>R-T-GSC-VBE120</p>	<p>V-BAR EXTENSION 120" (MAIN)</p> <p>Comes with measuring tape & pre-drilled holes for support</p>	<p>1 PIECE</p>



ROLLER/ ZEBRA™ SHADE COMPONENTS

All prices are subject to change without notice

FEB 16, 2024

 16	R-T-GSC-DB-773	SHADE CUTTER M755 DRIVE BELT	1 PIECE
 16	R-T-GSC-HDK-23-1	SHADE CUTTER M755 HEAVY DUTY CUTTER KNIFE	1 PIECE
 16	R-T-GSC-EP-1.25	CUTTER END PLUG FOR 1.25" TUBE (one groove)	1 PIECE
 16	R-T-GSC-EP-1.5	CUTTER END PLUG FOR 1.5" TUBE (one groove)	1 PIECE



ROLLER/ ZEBRA™ SHADE COMPONENTS

All prices are subject to change without notice

FEB 16, 2024

 <p>16</p>	<p>R-T-GSC-EP-1.625</p>	<p>CUTTER END PLUG FOR 1.625" TUBE (two grooves)</p>	<p>1 PIECE</p>
 <p>16</p>	<p>R-T-GSC-EP-2</p>	<p>CUTTER END PLUG FOR 2" TUBE (four grooves)</p>	<p>1 PC</p>
 <p>16</p>	<p>R-T-GSC-AMT</p>	<p>ADHESIVE BACKED MEASURING TAPE, 3/4" X 20 FT</p>	<p>1 PC</p>

MACHINERY



ROLLER/ ZEBRA™ SHADE COMPONENTS

All prices are subject to change without notice

FEB 16, 2024

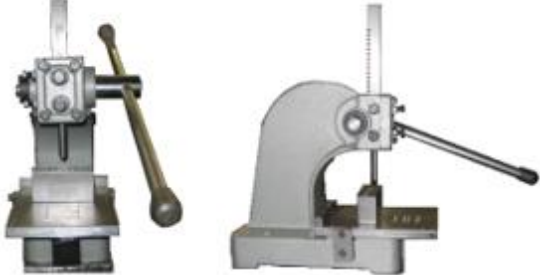
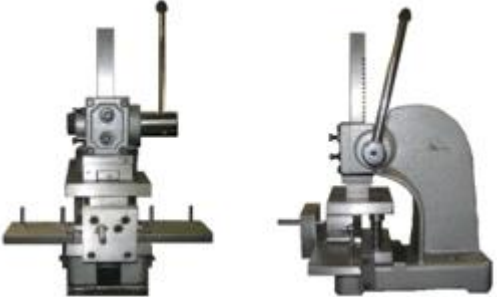
 <p>16</p>	<p>R-T-BAP</p>	<p>DIO & DUO BRACKET ASSEMBLER PRESS (Front View & Side View)</p> <p>Used to assemble DUO and DIO Brackets With DUO/DIO Bases & Mini Mounts</p>	<p>1 PIECE</p>
 <p>16</p>	<p>R-T-FN</p>	<p>FASCIA & FASCIA BRACKET NOTCHER MACHINE (Front & Side View)</p> <p>Use to Notch Bottom of 2.5", 3", & 4" Fascia & Fascia Support Brackets For Chains</p> <p>Customize Brackets As Needed</p>	<p>1 PIECE</p>



ROLLER/ ZEBRA™ SHADE COMPONENTS

All prices are subject to change without notice

FEB 16, 2024

<p>16</p>	<p>M-DX701</p>	<p>INSPECTION HOIST, SINGLE COLUMN, 110V, 50/60 Hz MAX WEIGHT LIFT - 70LBS</p> <ul style="list-style-type: none"> • 16FT Height • 12FT Width • One set of support Bracket on stand • Measuring tape on column • Four movable hanging brackets (Extra bracket at \$30/each) 	<p>1 SET</p>
<p>16</p>	<p>M-DX701-1</p>	<p>INSPECTION HOIST, DOUBLE COLUMN, 110V, 50/60 Hz MAX WEIGHT LIFT - 70LBS</p> <ul style="list-style-type: none"> • 13.4 FT Height • 9.8 FT Hang Width • 6.25 FT X 2.5 FT Base • One set of support Bracket on stand • Measuring tape on column • Two movable hanging brackets (Extra brackets at \$30/each) 	<p>1 SET</p>



ROLLER/ ZEBRA™ SHADE COMPONENTS

All prices are subject to change without notice

FEB 16, 2024

	R-TABLE	CUSTOM MADE FABRIC CUTTING TABLE 9 FT x 11 FT, STEEL	1 SET
		* INCLUDED WITH MEASURING TAPE ITEM# R-T-GSC-AMT**	

16